



Featuring  
**ASPEN,  
VERONA &  
BOUTIQUE  
FABRICS**  
Options

2020



Midwest  
Designer  
Supply

[www.midwestdesignersupply.com](http://www.midwestdesignersupply.com)

888-523-2611  
262-524-1007 (fax)

## CELLULAR SHADES COLLECTION

Cellular Shades / Odysee™ Cellular Blinds



Manufacturer's Price List and Reference Guide  
*Effective February 1, 2020*

## Comfortex Cellular, Prelude Shades and Cellular Blinds Price List and Reference Guide | Effective February 1, 2020

This price list and reference guide contains product pricing, product specifications and technical information for the complete line of Comfortex Cellular, Prelude Shades and Odysee Cellular Blinds.

<b>Cellular and Prelude Shades Overview</b>	<b>Page</b>
Key Features/Hardware Options	1-2
Fabric Collections	3
Size Standards	4-6
Product Options Availability	7
Shade Stack Heights	8-9
Pricing Examples	9
Upgrade Options/Surcharges.	10

### Rectangular

<b>Light Filtering:</b> Boutique 3/4", Linen Weave 3/4", Aspen and Verona 3/4"	<b>Price Group 1</b>	11
<b>Room Darkening:</b> Boutique 3/4", Linen Weave 3/4" and Verona 3/4"	<b>Price Group 2</b>	12
Premiere 1/2" Light Filtering	<b>Price Group 3</b>	13
Premiere 1/2" Blackout	<b>Price Group 4</b>	14
Premiere 3/4" Light Filtering	<b>Price Group 5</b>	15
Premiere 3/4" Blackout	<b>Price Group 6</b>	16
Debut 1/2" Single Light Filtering	<b>Price Group 7</b>	17
Debut 3/4" Light Filtering	<b>Price Group 8</b>	18
Debut 1/2" Double Light Filtering	<b>Price Group 8</b>	18
Symphony 3/8" Light Filtering	<b>Price Group 9</b>	19
Symphony 3/8" Blackout	<b>Price Group 10</b>	20
Prelude 3/4" Light Filtering	<b>Price Group 11</b>	21
Prelude 3/4" Blackout.	<b>Price Group 12</b>	22
SlumberShade Premiere Blackout.	<b>Price Group 13</b>	23

### Ovation Cellular Sliders

Size Standards - Ovation Cellular Slider Shades	24	
Ovation Cellular Slider Shades Light Filtering	<b>Price Group 14</b>	25
Prelude Ovation Cellular Slider Shades Light Filtering	<b>Price Group 15</b>	25
Ovation Cellular Slider Shades Room Darkening	<b>Price Group 16</b>	26
Prelude Ovation Cellular Slider Shades Blackout	<b>Price Group 17</b>	26

### Specialty Shaped Shades

#### Starburst™ Arches and Quarter Rounds

Size Standards - Specialty Shaped Shades	27-28	
Boutique 3/4" Light Filtering, Debut 1/2" Single Light Filtering, Debut 1/2" Double Light Filtering, Debut 3/4" Light Filtering, Linen Weave 3/4" Light Filtering, Premiere 1/2" Light Filtering, Premiere 3/4" Light Filtering, Symphony 3/8" Light Filtering and Flame Resistant, and Verona 3/4" Light Filtering	<b>Price Group 18</b>	29
Prelude 3/4" Light Filtering	<b>Price Group 19</b>	29
Boutique 3/4" Room Darkening, Linen Weave 3/4" Room Darkening, Premiere 1/2" Blackout, Premiere 3/4" Blackout, Symphony 3/8" Blackout and Verona 3/4" Room Darkening	<b>Price Group 20</b>	30
Prelude 3/4" Blackout	<b>Price Group 21</b>	30

**Sunset™ Arches**

Verona 3/4" Light Filtering, Boutique 3/4" Light Filtering, Debut 1/2" Single Light Filtering, Debut 3/4" Light Filtering, Debut 1/2" Double Light Filtering, Linen Weave 3/4" Light Filtering, Premiere 1/2" Light Filtering, Premiere 3/4" Light Filtering, Symphony 3/8" Light Filtering and Flame Resistant . . . . . **Price Group 22** . . . . . 31

Prelude 3/4" Light Filtering . . . . . **Price Group 23** . . . . . 31

Boutique 3/4" Room Darkening, Linen Weave 3/4" Room Darkening, Premiere 1/2" Blackout, Premiere 3/4" Blackout, Symphony 3/8" Blackout and Verona 3/4" Room Darkening . . . . . **Price Group 24** . . . . . 32

Prelude 3/4" Blackout . . . . . **Price Group 25** . . . . . 32

**Trapezoids and Octagons**

Boutique 3/4" Light Filtering, Debut 1/2" Single Light Filtering, Debut 1/2" Double Light Filtering, Debut 3/4" Light Filtering, Linen Weave 3/4" Light Filtering, Premiere 1/2" Light Filtering, Premiere 3/4" Light Filtering, Symphony 3/8" Light Filtering and Flame Resistant, Verona 3/4" Light Filtering . . . . . **Price Group 26** . . . . . 33

Prelude 3/4" Light Filtering . . . . . **Price Group 27** . . . . . 33

Boutique 3/4" Room Darkening, Linen Weave 3/4" Room Darkening, Premiere 1/2" Blackout, Premiere 3/4" Blackout, Symphony 3/8" Blackout and Verona 3/4" Room Darkening . . . . . **Price Group 28** . . . . . 34

Prelude 3/4" Blackout . . . . . **Price Group 29** . . . . . 34

**Soprano® Skylights and Greenhouse Shades**

Size Standards - Skylight and Greenhouse Shades . . . . . 35

**Light Filtering:** Boutique 3/4", Linen Weave 3/4", Aspen and Verona 3/4" . . . . . **Price Group 30** . . . . . 36

**Room Darkening:** Boutique 3/4", Linen Weave 3/4", Verona 3/4" and Karmalite . **Price Group 31** . . . . . 36

**Balcony™ Shading System**

Debut 1/2" Light Filtering, Symphony 3/8" Light Filtering and Flame Resistant . . . . . **Price Group 32** . . . . . 37

Symphony 3/8" Blackout . . . . . **Price Group 33** . . . . . 38

**Mezzo Motorized Skylight Shading System**

Boutique 3/4" Light Filtering, Debut 1/2" Single Light Filtering, Debut 3/4" Light Filtering, Debut 1/2" Double Light Filtering, Linen Weave 3/4" Light Filtering, Premiere 1/2" Light Filtering, Premiere 3/4" Light Filtering, Symphony 3/8" Light Filtering and Flame Resistant, and Verona 3/4" Light Filtering . . . . . **Price Group 34** . . . . . 39

Boutique 3/4" Room Darkening, Linen Weave 3/4" Room Darkening, Premiere 1/2" Blackout, Premiere 3/4" Blackout, Symphony 3/8" Blackout, and Verona 3/4" Room Darkening . . . . . **Price Group 35** . . . . . 40

**Prelude Skylight Shading System**

Prelude 3/4" Light Filtering . . . . . **Price Group 36** . . . . . 41

Prelude 3/4" Blackout . . . . . **Price Group 37** . . . . . 41

**French Door Décor**

Size Standards - Door Decor Hardware Shades . . . . . 42

**Non-Movable**

Boutique 3/4" Light Filtering, Debut 1/2" Single Light Filtering, Linen Weave 3/4" Light Filtering, Premiere 1/2" Light Filtering, Symphony 3/8" Light Filtering and Flame Resistant, and Verona 3/4" Light Filtering . . . . . **Price Group 38** . . . . . 43

	Page
<b>Movable</b>	
Debut ½" Single Light Filtering, Premiere ½" Light Filtering, Symphony ¾"	
Light Filtering and Flame Resistant . . . . .	Price Group 39 . . . . . 44
<b>Non-Movable</b>	
Boutique ¾" Room Darkening, Linen Weave ¾" Room Darkening,	
Premiere ½" Blackout, Symphony ¾" Blackout and Verona ¾" Blackout . . . . .	Price Group 40 . . . . . 45
<b>Movable</b>	
Premiere ½" Blackout and Symphony ¾" Blackout . . . . .	Price Group 41 . . . . . 46
<b>Hardware - All fabrics except Prelude</b>	
Standard and Deluxe Cord Lock Shades . . . . .	47-48
Cord Loop Hardware System . . . . .	49-50
Cordless Ultra Hardware System . . . . .	51-52
Cordless Lift & Lock . . . . .	53-54
Simplicity Motorized Cellular Shades . . . . .	55-56
Rechargeable Simplicity Motorized Cellular Shades . . . . .	57-59
Motorized Top Down-Bottom Up Shades . . . . .	60-61
EZ Charge Extension Wand . . . . .	62
Low Voltage Hard Wiring . . . . .	63
Simplicity Smart Controller . . . . .	64
Rechargeable PowerTouch Motorized Cellular Shades . . . . .	65-66
Ovation Cellular Slider . . . . .	67-68
Insulating SlumberShades . . . . .	69-70
Starburst Arches . . . . .	71
Sunset Arches . . . . .	72-73
Quarter Rounds . . . . .	74-75
Trapezoids and Octagons . . . . .	76-77
Soprano Skylights and Greenhouse Shades . . . . .	78-79
Balcony Shading System . . . . .	80-81
Mezzo Motorized Skylight Shading System . . . . .	82-84
Door Decor . . . . .	85-86
Day - Night Shades . . . . .	87-88
<b>Custom Graphics</b>	
Custom Graphics . . . . .	89
<b>Hardware - Prelude</b>	
Prelude Standard Cord Lock Shades . . . . .	90-91
Prelude Cord Loop Hardware System . . . . .	92-93
Prelude Cordless Ultra Hardware System . . . . .	94-95
Prelude Cordless Lift & Lock . . . . .	96-97
Prelude Rechargeable Simplicity Motorized Cellular Shades . . . . .	98-100
Prelude Motorized Top Down-Bottom Up . . . . .	101-102
Prelude Rechargeable PowerTouch Motorized Cellular Shades . . . . .	103-104
Prelude Ovation Cellular Slider . . . . .	105-106
Prelude Starburst Arches . . . . .	107
Prelude Sunset Arches . . . . .	108-109
Prelude Quarter Rounds . . . . .	110
Prelude Trapezoids and Octagons . . . . .	111-112
Prelude Skylight Shading System . . . . .	113
<b>Cellular Shades General Information</b>	
Highlights Cornice Valances . . . . .	114
Fabric Characteristics . . . . .	114
Cut-Outs . . . . .	114

## **Odysee Cellular Blinds**







Key Features/Hardware Options. . . . .	115
Pricing Examples. . . . .	115

Odysee Light Filtering . . . . .	116
Odysee Hardware . . . . .	117
Operating Cords. . . . .	118
Stack Heights . . . . .	118
Odysee Vane Characteristics . . . . .	118
Rechargeable Motorized Odysee Cellular Blinds. . . . .	119-120
Operating Odysee Blinds. . . . .	121
Odysee Certified Fabrics . . . . .	121
Measuring Instructions for Odysee Cellular Blinds . . . . .	124
Cleaning and Care of Odysee Cellular Blinds. . . . .	123

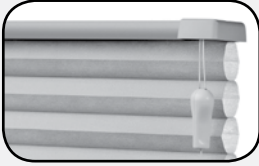
## **General Information**

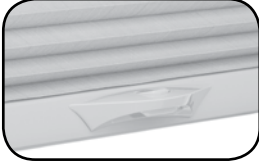
Scotchgard Protection. . . . .	122
Certified Fabrics . . . . .	122
Symphony Flame Resistant Fabrics . . . . .	122
EZ Level . . . . .	122
Cleaning and Care . . . . .	123
Measuring Instructions . . . . .	124
Measuring Specialty Shades . . . . .	124
Making the Perfect Template . . . . .	125
Conditions Of Sale . . . . .	126
Policies. . . . .	126
Freight Policy . . . . .	126
Child Safety . . . . .	127
Cellular Shades and Odysee Cellular Blinds Warranty Information . . . . .	128
Motorized Shades Warranty. . . . .	128
Scotchgard™ Warranty . . . . .	129







**Cellular Shade Collection**  
**HARDWARE OPTIONS**

	Key Features	Color Options	Hardware Size (Depth x Height)	Widths & Lengths*	More Information
<p><b>Cord Lock</b></p> 	<ul style="list-style-type: none"> <li>Reliable cord lock</li> <li>Sleek, color coordinated rails</li> <li>UV resistant materials</li> </ul>	<ul style="list-style-type: none"> <li>Color Coordinated</li> <li>Fabric Wrapped</li> <li>Brushed Nickel</li> <li>Oil Rubbed Bronze</li> </ul>	<p>Standard Head Rail: 1 7/8" x 1/2"</p> <p>Deluxe Head Rail: 2 3/8" x 1/2"</p>	<p>Width: 8" up to 144"</p> <p>Length: 8" up to 120"</p>	Page 47
<p><b>Cord Loop</b></p> 	<ul style="list-style-type: none"> <li>Great for large windows</li> <li>Smooth &amp; quiet operation</li> </ul>	<ul style="list-style-type: none"> <li>Color Coordinated</li> <li>Fabric Wrapped</li> <li>Brushed Nickel</li> <li>Oil Rubbed Bronze</li> </ul>	2 1/4" x 1 1/2"	<p>Width: 14" up to 144"</p> <p>Length: 8" up to 120"</p>	Page 49
<p><b>Cordless Ultra</b></p> 	<ul style="list-style-type: none"> <li>Child safe</li> <li>No visible cords</li> <li>Smooth &amp; quiet operation</li> <li>Sleek clear handle on rails</li> <li>Two-On-One option available</li> </ul>	<ul style="list-style-type: none"> <li>Color Coordinated</li> <li>Fabric Wrapped</li> <li>Brushed Nickel</li> <li>Oil Rubbed Bronze</li> </ul>	2 1/4" x 1 1/2"	<p>Width: 18" up to 144"</p> <p>Length: 8" up to 84"</p>	Page 51
<p><b>Cordless Lift &amp; Lock</b></p> 	<ul style="list-style-type: none"> <li>Child safe</li> <li>Easy push button operation</li> <li>Rails lock securely in place in any position</li> <li>Color coordinated rails and handle</li> </ul>	<ul style="list-style-type: none"> <li>Color Coordinated</li> <li>Fabric Wrapped</li> <li>Oil Rubbed Bronze</li> </ul>	<p>Standard Head Rail: 1 7/8" x 1/2"</p> <p>Deluxe Head Rail: 2 3/8" x 1/2"</p> <p>Bottom Rail: 1 7/8" x 1 1/8"</p>	<p>Width: 16" up to 96"</p> <p>Length: 8" up to 84"</p>	Page 53
<p><b>Simplicity Motorization</b></p> 	<ul style="list-style-type: none"> <li>Raise &amp; lower shade with click of a button</li> <li>Great for large and hard to reach windows</li> <li>Remote can operate multiple shades</li> </ul>	<ul style="list-style-type: none"> <li>Color Coordinated</li> <li>Fabric Wrapped</li> <li>Oil Rubbed Bronze</li> <li>Brushed Nickel</li> </ul>	2 1/4" x 1 1/2"	<p>Width: 18" to 108"</p> <p>Length: 8" to 120"</p>	Page 55
<p><b>Simplicity Rechargeable Motorization</b></p> 	<ul style="list-style-type: none"> <li>Raise &amp; lower shade with click of a button</li> <li>Great for large and hard to reach windows</li> <li>Remote can operate multiple shades</li> <li>Standard or Top Down-Bottom Up</li> </ul>	<ul style="list-style-type: none"> <li>Color Coordinated</li> <li>Fabric Wrapped</li> <li>Oil Rubbed Bronze</li> <li>Brushed Nickel</li> </ul>	2 1/4" x 1 1/2"	<p>Width: 18" up to 108"</p> <p>Length: 8" up to 120"</p>	Page 57
<p><b>PowerTouch™ Rechargeable Cordless Wand</b></p> 	<ul style="list-style-type: none"> <li>Raise &amp; lower shade with push of a button</li> <li>Just "Touch &amp; Go" to operate the shade</li> <li>Set your favorite shade position</li> <li>Easy access to charging port on side of pendant</li> </ul>	<ul style="list-style-type: none"> <li>Wand and pendant available in white or black</li> </ul>	2 1/4" x 1 1/2"	<p>Width: 18" up to 144"</p> <p>Length: 8" up to 120"</p>	Page 65

\* Maximum widths and lengths listed do not take into account square foot or weight limitations. Make sure to refer to shaded areas on price groups for maximum size availability by fabric style.

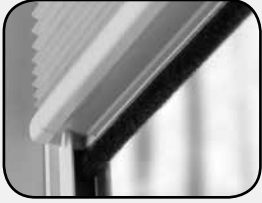
Cellular Shade Collection  
HARDWARE OPTIONS

CELLULAR SHADE COLLECTION

	Key Features	Color Options	Hardware Size (Depth x Height)	Widths & Lengths*	More Information
<b>Ovation™ Slider</b> 	<ul style="list-style-type: none"> <li>Vertically oriented fabric glides across window</li> <li>Shade can stack left, right or center</li> <li>Great for sliding glass doors or room dividers</li> </ul>	<ul style="list-style-type: none"> <li>White (Standard)</li> <li>Ivory</li> <li>Beige</li> <li>Tan</li> <li>Gray</li> </ul>	3 5/8" x 1 3/4"	Width: 12" up to 168"  Length: 24" up to 120"	Page 67
<b>French Door Décor</b> 	<ul style="list-style-type: none"> <li>Great option for narrow windows and doors</li> <li>Available in moveable &amp; non-moveable rails</li> <li>No Pull cords</li> </ul>	<ul style="list-style-type: none"> <li>Color Coordinated</li> <li>Fabric Wrapped</li> <li>Brushed Nickel</li> <li>Oil Rubbed Bronze</li> </ul>	Standard Head Rail: 1 7/8" x 1/2"  Deluxe Head Rail: 2 3/8" x 1/2"	Width: 6" up to 36"  Length: 12" up to 96"	Page 85
<b>Insulating SlumberShade™</b> 	<ul style="list-style-type: none"> <li>Ultimate blackout shade</li> <li>Tracks keep out light, cold or heat</li> <li>Perfect for nurseries, day sleepers</li> <li>Available in Cord Lock, Cord Loop, Cordless and motorized</li> </ul>	<ul style="list-style-type: none"> <li>Color Coordinated</li> <li>Fabric Wrapped</li> <li>Brushed Nickel</li> <li>Oil Rubbed Bronze</li> <li>Sidetracks are available in white, tan or Bronze</li> </ul>	Dependant on hardware choice	Width: 9" up to 96"  Length: 8" up to 120"	Page 69
<b>Top Down-Bottom Up</b> 	<ul style="list-style-type: none"> <li>Lower shade from top: raise from bottom</li> <li>Great for privacy</li> <li>Ideal for light control</li> <li>Available in Cord Lock, Cord Loop, Cordless and motorized</li> </ul>	<ul style="list-style-type: none"> <li>Color Coordinated</li> <li>Fabric Wrapped</li> <li>Oil Rubbed Bronze</li> <li>Brushed Nickel</li> </ul>	Dependant on hardware choice	Width: 18" up to 120"  Length: 8" up to 120"	See Product Availability Page 7-8
<b>Two on One Head Rail</b> 	<ul style="list-style-type: none"> <li>Operate two shades on one rail</li> <li>Great for larger windows</li> <li>Individually operating shades</li> </ul>	<ul style="list-style-type: none"> <li>Color Coordinated</li> <li>Fabric Wrapped</li> <li>Oil Rubbed Bronze</li> <li>Brushed Nickel</li> </ul>	Dependent on Style See Above	Width: 16" up to 144"  Length: 8" up to 120"	See Product Availability Page 7-8
<b>Highlights Cornice Valance</b> 	<ul style="list-style-type: none"> <li>Adds height to windows</li> <li>Available as inside and outside mount</li> <li>Easy to install</li> </ul>	<ul style="list-style-type: none"> <li>100+ Envision fabrics</li> <li>100s of patterns and colors</li> </ul>	Width: 24" x 216"  Valance Height: 6"  Returns: 1 1/2" x 6"	Varies by selected fabric  Width: 12" up to 216"	Page 116

\* Maximum widths and lengths listed do not take into account square foot or weight limitations. Make sure to refer to shaded areas on price groups for maximum size availability by fabric style.

Make sure to consult specification charts for specific fabric styles.

**Cellular Shade Collection**  
**FABRIC COLLECTIONS**

CELLULAR SHADE COLLECTION

Fabric Collection	Cell Size and Structure	Opacities	Fabric Content
Boutique	<ul style="list-style-type: none"> <li>• ¾ -Inch</li> <li>• Single Cell</li> </ul>	<ul style="list-style-type: none"> <li>• Light Filtering</li> <li>• Karma-Light Room Darkening</li> </ul>	<ul style="list-style-type: none"> <li>• Light Filtering: Non-Woven Polyester</li> <li>• Room Darkening: Opaque lining pressed between two layers of non-woven polyester</li> <li>• Karma-Light technology insures color on front fabric will not be distorted like traditional blackout shades. Opaque lining is used only on back side of the cells</li> </ul>
Debut*	<ul style="list-style-type: none"> <li>• ½-Inch Single Cell</li> <li>• ¾-Inch Single Cell</li> <li>• ½-Inch Double Cell</li> </ul>	<ul style="list-style-type: none"> <li>• Light Filtering</li> </ul>	<ul style="list-style-type: none"> <li>• Light Filtering: Non-Woven Polyester</li> </ul>
Linen Weave	<ul style="list-style-type: none"> <li>• ¾ -Inch</li> <li>• Single Cell</li> </ul>	<ul style="list-style-type: none"> <li>• Light Filtering</li> <li>• Karma-Light Room Darkening</li> </ul>	<ul style="list-style-type: none"> <li>• Light Filtering: Non-Woven Polyester</li> <li>• Karma-Light technology insures color on front fabric will not be distorted like traditional blackout shades.</li> </ul>
Premiere**	<ul style="list-style-type: none"> <li>• ½-Inch</li> <li>• ¾-Inch</li> <li>• Single Cell</li> </ul>	<ul style="list-style-type: none"> <li>• Light Filtering</li> <li>• Blackout</li> <li>• Karma-Light Room Darkening</li> </ul>	<ul style="list-style-type: none"> <li>• Light Filtering: Non-Woven Polyester</li> <li>• Blackout: Opaque lining pressed between two layers of non-woven polyester</li> <li>• Karma-Light technology insures color on front fabric will not be distorted like traditional blackout shades. Opaque lining is used only on back side of the cells</li> <li>• Limited Blackout colors available, refer to <a href="http://www.comfortex.com">www.comfortex.com</a></li> </ul>
Aspen	<ul style="list-style-type: none"> <li>• ¾-Inch</li> <li>• Double Cell</li> </ul>	<ul style="list-style-type: none"> <li>• Light Filtering</li> </ul>	<ul style="list-style-type: none"> <li>• Light Filtering: Non-Woven Polyester</li> </ul>
Symphony	<ul style="list-style-type: none"> <li>• ¾-Inch</li> <li>• Double Cell</li> </ul>	<ul style="list-style-type: none"> <li>• Light Filtering</li> <li>• Flame Retardant Light Filtering</li> <li>• Blackout</li> </ul>	<ul style="list-style-type: none"> <li>• Light Filtering: Non-Woven Polyester</li> <li>• Blackout: Non-Woven Polyester with foil lining</li> </ul>
Verona	<ul style="list-style-type: none"> <li>• ¾ Inch</li> <li>• Single Cell</li> </ul>	<ul style="list-style-type: none"> <li>• Light Filtering</li> <li>• Karma-Light Room Darkening</li> </ul>	<ul style="list-style-type: none"> <li>• Light Filtering: Non-Woven Polyester</li> <li>• Room Darkening: Opaque lining pressed between two layers of non-woven polyester</li> <li>• Karma-Light technology insures color on front fabric will not be distorted like traditional blackout shades. Opaque lining is used only on back side of the cells</li> </ul>

\* Debut Light Filtering fabrics include solid colors, Homespun, Country Woven, Florance, Strata, Angel Hair, Blossom, Strie and Terrazzo.

\*\* Premiere fabrics include the following prints: Spheres and Tuscan Scroll. Premiere Blackout fabrics include the following prints: Homespun, Country Woven, Florance, Strata, Angel Hair and Blossom.



**Cellular Shade Collection**  
**SIZE STANDARDS**

**CELLULAR SHADE COLLECTION**

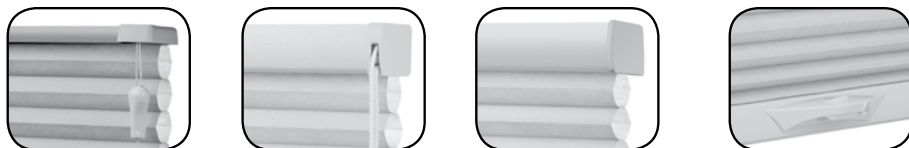

	Minimum	Cord Lock		Cord Loop		Cordless Ultra		Cordless Lift & Lock	
		Bottom Up	Top Down Bottom Up	Bottom Up	Top Down Bottom Up	Bottom Up	Top Down Bottom Up	Bottom Up	Top Down Bottom Up
<b>ALL FABRICS</b> (except 3/4" Prelude)	Minimum Width	8"	12"	14"	22"	15" OB or 15 3/8" IB	18" OB or 18 3/8" IB	16" OB or 16 3/8" IB	20" OB or 20 3/8" IB
	Min. Length	8"	8"	8"	8"	8"	8"	8"	8"
Prelude 3/4"	Min. Width	8"	10"	18"	24"	16"	16"	12"	16" OB or 16 1/2" IB
	Min. Length	12"	12"	12"	12"	12"	12"	12"	12"

Light Filtering	Price Group	Page		Cord Lock		Cord Loop		Cordless Ultra		Cordless Lift & Lock	
				Bottom Up	Top Down Bottom Up	Bottom Up	Top Down Bottom Up	Bottom Up	Top Down Bottom Up	Bottom Up	Top Down Bottom Up
Boutique 3/4"	1	11	Maximum Width & Length								
Debut	7 & 8	17-18									
Premiere	3	13									
Linen Weave 3/4"	1	11									
Aspen 3/8"	1	11									
Symphony 3/8"	9	19	Refer to shaded area in price grids for max size (sq ft) by fabric style	108" width* 120" length	96" width 96" length	108" width 120" length	108" width 120" length	108" width* 84" length	96" width 84" length	96" width 84" length	96" width 84" length
Verona 3/4"	1	11									
Prelude 3/4"	11	21	Maximum Width & Length - Sq Ft.	60" width 120" length 50 sq ft	72" width 96" length 50 sq ft	120" width 120" length 100 sq ft	120" width 120" length 100 sq ft	120" width 84" length 70 sq ft	96" width 84" length 56 sq ft	84" width 84" length 49 sq ft	84" width 84" length 49 sq ft

Room Darkening & Blackout	Price Group	Page		Cord Lock		Cord Loop		Cordless Ultra		Cordless Lift & Lock	
				Bottom Up	Top Down Bottom Up	Bottom Up	Top Down Bottom Up	Bottom Up	Top Down Bottom Up	Bottom Up	Top Down Bottom Up
Boutique 3/4"	2	12	Maximum Width & Length								
Linen Weave 3/4"	2	12									
Premiere	4	14									
Verona 3/4"	2	12	Refer to shaded area in price grids for max size (sq ft) by fabric style	108" width* 120" length	84" width 96" length	108" width* 120" length	108" width* 120" length	108" width* 84" length	96" width* 84" length	96" width 84" length	96" width 84" length
Symphony 3/8"	10	20		120" width 120" length	84" width 96" length	120" width 120" length	120" width 120" length	Not Available	84" width 84" length	84" width 84" length	84" width 84" length
Prelude 3/4"***	12	22	Maximum Width & Length - Sq Ft.	60" width 120" length 50 sq ft	72" width 96" length 50 sq ft	120" width 120" length 100 sq ft	120" width 120" length 100 sq ft	96" width 84" length 56 sq ft	96" width 84" length 56 sq ft	84" width 84" length 49 sq ft	84" width 84" length 49 sq ft

	Cord Lock		Cord Loop		Cordless Ultra		Cordless Lift & Lock	
	Bottom Up	Top Down Bottom Up	Bottom Up	Top Down Bottom Up	Bottom Up	Top Down Bottom Up	Bottom Up	Top Down Bottom Up
Stacking Heights Information On Page More Information On Page	Page 8-9	Page 47	Page 8-9	Page 49	Page 8-9	Page 51	Page 8-9	Page 53

Cordlock: Please Note: For any shades under 12" width, the maximum height is 80".  
Cordloop and cordless shades less than 24" in width are limited to 84" in length

\*\*\*Maximum width for side mount refer to hardware pages.

**Cellular Shade Collection**  
**SIZE STANDARDS**

CELLULAR SHADE COLLECTION



	Minimum	Motorization		Two-On-One Head Rail		
		Simplicity	Simplicity+ Rechargeable	PowerTouch Rechargeable	Cord Lock	Cord Loop/Cordless
<b>ALL FABRICS (except 3/4" Prelude)</b>	Minimum Width	18"		18"	16"	36"
	Min. Length	8"		8"	8"	8"
<b>Prelude 3/4"</b>	Min. Width	18"		18"	16"	36"
	Min. Length	12"		12"	12"	12"

Light Filtering	Price Group	Page		Motorization		Two-On-One Head Rail	
				Simplicity	Simplicity Rechargeable	PowerTouch Rechargeable	Cord Lock
<b>Boutique 3/4"</b>	1	11	Maximum Width & Length Refer to shaded area in price grids for max size (sq ft) by fabric style	108" width 120" length**	108" width 120" length**	144" width 120" length	144" width 120" length++
<b>Debut</b>	7 & 8	17					
<b>Premiere</b>	3	13					
<b>Linen Weave 3/4"</b>	1	11					
<b>Aspen 3/8"</b>	1	11					
<b>Symphony 3/8"</b>	9	19					
<b>Verona 3/4"</b>	1	11					
<b>Prelude 3/4"</b>	11	21	Maximum Width & Length - Sq Ft.	96" width 96" length** 50 sq ft	96" width 96" length** 50 sq ft	120" width 120" length 50 sq ft	120" width 120" length++ 50 sq ft

Room Darkening & Blackout	Price Group	Page		Motorization		Two-On-One Head Rail	
				Simplicity	Simplicity Rechargeable	PowerTouch Rechargeable	Cord Lock
<b>Boutique 3/4"</b>	2	12	Maximum Width & Length Refer to shaded area in price grids for max size (sq ft) by fabric style	108" width 120" length**	108" width 120" length**	144" width 120" length	144" width 120" length++
<b>Linen Weave 3/4"</b>	2	12					
<b>Premiere</b>	4	14					
<b>Verona 3/4"</b>	2	12					
<b>Symphony 3/8"</b>	10	20					
<b>Prelude 3/4"</b>	12	22	Maximum Width & Length - Sq Ft.	96" width 96" length** 50 sq ft	96" width 96" length** 50 sq ft	120" width 120" length 50sq ft	120" width 120" length++ 50 sq ft

	Motorization		Two-On-One Head Rail		
	Simplicity	Simplicity Rechargeable	PowerTouch Rechargeable	Cord Lock	Cord Loop/Cordless
Stacking Heights Information On Page More Information On Page	Page 8-9 Page 55		Page 8-9 Page 65	Page 8-9 Page 7	

Please Note: For any shades under 12" width, the maximum height is 80".  
 \* Maximum widths and lengths listed do not take into account square foot or weight limitations. Make sure to refer to shaded areas on price groups for maximum size availability by fabric style.  
 \*\* Motorized shades less than 24" in width are limited to a maximum of 60" in length.  
 +Simplicity Rechargeable Top Down-Bottom Up motorization minimum width is 24" IB and 23 3/8" OB.  
 ++ Cordloop is 120", Cordless is 84" maximum length

Cellular Shade Collection  
**SIZE STANDARDS**

CELLULAR SHADE COLLECTION



		SlumberShade Cord Lock		SlumberShade Cord Loop		SlumberShade Cordless		Motorization
		Bottom Up	Top Down Bottom Up	Bottom Up	Top Down Bottom Up	Bottom Up	Top Down Bottom Up	Simplicity+ Rechargeable
ALL FABRICS	Minimum Width	9"	13"	15"	25"	16" IB	19"	19"
	Min. Length	8"	8"	8"	8"	8"	8"	8"

				SlumberShade Cord Lock		SlumberShade Cord Loop		SlumberShade Cordless		Motorization
				Bottom Up	Top Down Bottom Up	Bottom Up	Top Down Bottom Up	Bottom Up	Top Down Bottom Up	Simplicity+ Rechargeable
<b>Light Filtering</b>	<b>Price Group</b>	<b>Page</b>								
Debut	7	17	Maximum Width & Length  Refer to shaded area in price grids for max size (sq ft) by fabric style							
Linen Weave	1	11								
Premiere	3	13								
Aspen 3/8"	1	11								
Symphony 3/8"	9	19								
Verona	1	11								
				96" width 120" length	96" width 96" length	96" width 120" length	96" width 120" length	96" width 84" length	96" width 84" length	108" width 120" length

				SlumberShade Cord Lock		SlumberShade Cord Loop		SlumberShade Cordless		Motorization
				Bottom Up	Top Down Bottom Up	Bottom Up	Top Down Bottom Up	Bottom Up	Top Down Bottom Up	Simplicity+ Rechargeable
<b>Room Darkening &amp; Blackout</b>	<b>Price Group</b>	<b>Page</b>								
Debut	8	18	Maximum Width & Length  Refer to shaded area in price grids for max size (sq ft) by fabric style							
Linen Weave	2	12								
Premiere	4	14								
Symphony 3/8"	10	20								
Verona	2	12								
				96" width 120" length	84" width 96" length	96" width 120" length	96" width 120" length	96" width 84" length	96" width 84" length	108" width 120" length
								Symphony Blackout not available as cordless		

				SlumberShade Cord Lock		SlumberShade Cord Loop		SlumberShade Cordless		Motorization
				Bottom Up	Top Down Bottom Up	Bottom Up	Top Down Bottom Up	Bottom Up	Top Down Bottom Up	Simplicity+ Rechargeable
Stacking Heights Information On Page More Information On Page				Page 8-9 Page 64		Page 8-9 Page 64		Page 8-9 Page 64		Page 8-9 Page 64

Please Note: For any shades under 12" width, the maximum height is 80".

Cellular Shade Collection

**HARDWARE OPTION AVAILABILITY**

Use this table to ensure your coordinating options and unique shapes are consistent with your product selections.

CELLULAR SHADE COLLECTION

	Verona 3/4" LF & RD	Boutique 3/4" LF & RD	Premiere 3/4" LF & RD	Linen Weave 3/4" LF & RD	Aspen 3/8" Light Filtering	Symphony Light Filtering	Symphony Blackout	Debut 1/2" Light Filtering	Debut 3/4" Light Filtering	Debut Double Cell Light Filtering
<b>STANDARD CORD LOCK</b>										
Standard Cord Lock	•	•	•	•	•	•	•	•	•	•
Top Down-Bottom Up	•	•	•	•	•	•	•	•	•	•
Two-On-One Head Rail	•	•	•	•	•	•	•	•	•	•
Day-Night	•	•	•	•	•	•	•	•	•	•
<b>CORD LOOP</b>										
Cord Loop	•	•	•	•	•	•	•	•	•	•
Cord Loop Top Down-Bottom Up	•	•	•	•	•	•	•	•	•	•
Cord Loop Two-On-One Head Rail	•	•	•	•	•	•	•	•	•	•
<b>CORDLESS ULTRA</b>										
Cordless Ultra	•	•	•	•	•	•	-	•	•	•
Cordless Two-On-One Head Rail	•	•	•	•	•	•	-	•	•	•
Cordless Ultra Top Down-Bottom Up	•	•	•	•	•	•	-	•	•	•
<b>CORDLESS LIFT &amp; LOCK</b>										
Cordless Lift & Lock	•	•	•	•	•	•	•	•	•	•
Cordless Lift & Lock Two-On-One Head Rail	•	•	•	•	•	•	•	•	•	•
Cordless Lift & Lock Top Down-Bottom Up	•	•	•	•	•	•	•	•	•	•
<b>MOTORIZATION</b>										
Simplicity Motorization	•	•	•	•	•	•	•	•	•	•
Simplicity Rechargeable Motorization	•	•	•	•	•	•	•	•	•	•
PowerTouch™ Rechargeable	•	•	•	•	•	•	•	•	•	•
Top Down-Bottom Up	•	•	•	•	•	•	•	•	•	•
<b>INSULATING SLUMBERSHADES</b>										
Cord Lock	•	-	•	•	•	•	•	•	•	•
Cord Lock Top Down-Bottom Up	•	-	•	•	•	•	•	•	•	•
Cordless Ultra	•	-	•	•	•	•	-	•	•	•
Cordless Ultra Top Down-Bottom Up	•	-	•	•	•	•	-	•	•	•
Cord Loop	•	-	•	•	•	•	•	•	•	•
Cord Loop Top Down-Bottom Up	•	-	•	•	•	•	•	•	•	•
Simplicity Motorization	•	•	•	•	•	•	•	•	•	•
Simplicity Rechargeable Motorization	•	•	•	•	•	•	•	•	•	•
<b>SKYLIGHTS AND SPECIALTY SHAPES</b>										
Balcony Shading System	-	-	-	-	-	•	•	•	-	-
French Door Decor	•	•	•	•	•	•	•	•	•	•
Mezzo Motorized Skylights	•	•	•	•	•	•	•	•	•	•
Octagon	•	•	•	•	•	•	•	•	•	•
Ovation Cellular Slider	•	•	•++	•	•	•	-	•	•	•
Quarter Round - Moveable	•	•	•	•	•	•	•	•	•	•
Quarter Round - Non-Movable	•	•	•	•	•	•	•	•	•	•
Soprano Skylights and Greenhouses	•	•	-	•	•	•	-	•	-	-
Starburst Arch - Movable	•	•	•	•	•	•	•	•	•	•
Starburst Arch - Non-Movable	•	•	•	•	•	•	•	•	•	•
Sunset Arch - Moveable	•*	•*	•	•*	•	•	-	•	•	•
Trapezoid	•	•	•	•	•	•	•	•	•	•

\* Light Filtering Fabric Only  
++ 3/4" Premiere fabrics only

# Cellular Shade Collection

## SHADE STACK HEIGHTS

Measurements are in inches. Shade stacking heights applicable when the shade is in the fully raised position.

CELLULAR SHADE COLLECTION

RECTANGULAR CORD LOCK - Includes head and bottom rails	48"	72"	84"	96"	108"	120"
Verona	2"	2 <sup>3</sup> / <sub>8</sub> "	2 <sup>5</sup> / <sub>8</sub> "	2 <sup>7</sup> / <sub>8</sub> "	3 <sup>1</sup> / <sub>8</sub> "	3 <sup>3</sup> / <sub>8</sub> "
Boutique	2"	2 <sup>3</sup> / <sub>8</sub> "	2 <sup>5</sup> / <sub>8</sub> "	2 <sup>7</sup> / <sub>8</sub> "	3 <sup>1</sup> / <sub>8</sub> "	3 <sup>3</sup> / <sub>8</sub> "
Debut 1/2" Double Cell Light Filtering	1 1/2"	1 3/8"	1 3/4"	1 7/8"	2"	2 1/8"
Debut 1/2" Single Cell Light Filtering	1 3/8"	2 3/4"	3"	3 3/8"	3 3/8"	4"
Debut 3/4" Single Cell Light Filtering	1 1/2"	1 3/8"	1 3/4"	1 7/8"	2"	2 1/8"
Linen Weave (All)	2"	2 <sup>3</sup> / <sub>8</sub> "	2 <sup>5</sup> / <sub>8</sub> "	2 <sup>7</sup> / <sub>8</sub> "	3 <sup>1</sup> / <sub>8</sub> "	3 <sup>3</sup> / <sub>8</sub> "
Premiere 1/2" Single Cell Blackout	2"	2 1/2"	2 <sup>5</sup> / <sub>8</sub> "	2 <sup>7</sup> / <sub>8</sub> "	3 <sup>1</sup> / <sub>8</sub> "	3 1/4"
Premiere 1/2" Single Cell Light Filtering	1 7/8"	2 1/4"	2 1/2"	2 <sup>5</sup> / <sub>8</sub> "	2 <sup>7</sup> / <sub>8</sub> "	3"
Premiere 3/4" Single Cell Blackout	2"	2 <sup>3</sup> / <sub>8</sub> "	2 <sup>5</sup> / <sub>8</sub> "	2 3/4"	3"	3 1/8"
Premiere 3/4" Single Cell Light Filtering	1 3/4"	2 1/8"	2 1/4"	2 3/8"	2 1/2"	2 5/8"
Aspen 3/8" Double Cell Light Filtering	2"	2 <sup>3</sup> / <sub>8</sub> "	2 <sup>5</sup> / <sub>8</sub> "	2 <sup>7</sup> / <sub>8</sub> "	3 <sup>1</sup> / <sub>8</sub> "	3 <sup>3</sup> / <sub>8</sub> "
Symphony 3/8" Double Cell Blackout	2"	2 1/2"	2 3/4"	3"	3 1/4"	3 1/2"
Symphony 3/8" Double Cell Light Filtering	2 1/4"	2 3/4"	3"	3 1/4"	3 1/2"	3 3/4"

CORD LOOP - CORDLESS ULTRA - MOTORIZATION - Includes head and bottom rails	48"	72"	84"	96"	108"	120"
Verona	3"	3 3/8"	3 5/8"	3 7/8"	4 1/8"	4 3/8"
Boutique	3"	3 3/8"	3 5/8"	3 7/8"	4 1/8"	4 3/8"
Debut 1/2" Double Cell Light Filtering	2 1/2"	2 5/8"	2 3/4"	2 7/8"	3"	3 1/8"
Debut 1/2" Single Cell Light Filtering	3 1/4"	3 3/4"	4"	4 3/8"	4 5/8"	5"
Debut 3/4" Single Cell Light Filtering	2 1/2"	2 5/8"	2 3/4"	2 7/8"	3"	3 1/8"
Linen Weave (All)	3"	3 3/8"	3 5/8"	3 7/8"	4 1/8"	4 3/8"
Premiere 1/2" Single Cell Blackout	3"	3 1/2"	3 5/8"	3 7/8"	4 1/8"	4 1/4"
Premiere 1/2" Single Cell Light Filtering	2 7/8"	3 1/4"	3 1/2"	3 5/8"	3 7/8"	4"
Premiere 3/4" Single Cell Blackout	3"	3 3/8"	3 5/8"	3 3/4"	4"	4 1/8"
Premiere 3/4" Single Cell Light Filtering	2 3/4"	3 1/8"	3 1/4"	3 3/8"	3 1/2"	3 5/8"
Aspen 3/8" Double Cell Light Filtering	3 1/4"	3 5/8"	3 7/8"	4 1/8"	4 3/8"	4 5/8"
Symphony 3/8" Double Cell Blackout	2 7/8"	3 3/8"	3 5/8"	3 7/8"	4 1/2"	4 3/4"
Symphony 3/8" Double Cell Light Filtering	3 1/8"	3 1/2"	3 3/4"	3 7/8"	4 1/8"	4 1/4"

For Top Down-Bottom Up, add 3/8"

CORDLESS LIFT & LOCK - Includes head and bottom rails	48"	60"	72"	84"	108"	120"
Verona	2 3/4"	3 1/8"	3 3/8"	3 5/8"	3 7/8"	4 1/8"
Boutique	2 3/4"	3 1/8"	3 3/8"	3 5/8"	3 7/8"	4 1/8"
Debut 1/2" Double Cell Light Filtering	2 1/4"	2 3/8"	2 1/2"	2 5/8"	2 3/4"	2 7/8"
Debut 1/2" Single Cell Light Filtering	3"	3 1/2"	3 3/4"	4 1/8"	4 3/8"	4 3/4"
Debut 3/4" Single Cell Light Filtering	2 1/4"	2 3/8"	2 1/2"	2 5/8"	2 3/4"	2 7/8"
Linen Weave (All)	2 3/4"	3 1/8"	3 3/8"	3 5/8"	3 7/8"	4 1/8"
Premiere 1/2" Single Cell Blackout	2 3/4"	3 1/4"	3 3/8"	3 5/8"	3 7/8"	4"
Premiere 1/2" Single Cell Light Filtering	2 5/8"	3 3/4"	3 1/4"	3 3/8"	3 1/2"	3 1/2"
Premiere 3/4" Single Cell Blackout	2 3/4"	3 1/8"	3 3/8"	3 1/2"	3 3/4"	3 7/8"
Premiere 3/4" Single Cell Light Filtering	2 1/4"	2 7/8"	3"	3 1/8"	3 3/8"	3 1/2"
Aspen 3/8" Double Cell Light Filtering	2 3/4"	3 1/8"	3 3/8"	3 5/8"	3 7/8"	4 1/8"
Symphony 3/8" Double Cell Blackout	2 3/4"	3 1/4"	3 1/2"	NA	NA	NA
Symphony 3/8" Double Cell Light Filtering	3"	3 1/2"	3 3/4"	4"	4 1/4"	4 1/2"

For Top Down-Bottom Up, add 1 1/4"

OVATION	84"	96"	108"	120"
All Fabrics	6 1/2"	7 1/4"	8"	8 3/4"

Ovations minimum fabric stack measures 6 1/2" regardless of the ordered width. Fabric stacking dimensions are determined by the slider's hardware, not ordered width.

# Prelude Shade

## SHADE STACK HEIGHTS

Measurements are in inches. Shade stacking heights applicable when the shade is in the fully raised position.

RECTANGULAR CORD LOCK - Includes head and bottom rails	48"	72"	84"	96"	108"	120"
Prelude Light Filtering	2"	2 <sup>3</sup> / <sub>8</sub> "	2 <sup>5</sup> / <sub>8</sub> "	2 <sup>7</sup> / <sub>8</sub> "	3 <sup>1</sup> / <sub>8</sub> "	3 <sup>3</sup> / <sub>8</sub> "
Prelude Blackout	1 <sup>1</sup> / <sub>2</sub> "	1 <sup>3</sup> / <sub>4</sub> "	1 <sup>7</sup> / <sub>8</sub> "	2"	2 <sup>1</sup> / <sub>8</sub> "	2 <sup>1</sup> / <sub>4</sub> "

For Top Down-Bottom Up, add <sup>5</sup>/<sub>8</sub>"

CORD LOOP - CORDLESS ULTRA - MOTORIZATION - Includes head and bottom rails	48"	72"	84"	96"	108"	120"
Prelude Light Filtering	3"	3 <sup>3</sup> / <sub>8</sub> "	3 <sup>5</sup> / <sub>8</sub> "	3 <sup>7</sup> / <sub>8</sub> "	4 <sup>1</sup> / <sub>8</sub> "	4 <sup>3</sup> / <sub>8</sub> "
Prelude Blackout	2 <sup>1</sup> / <sub>4</sub> "	2 <sup>1</sup> / <sub>2</sub> "	2 <sup>5</sup> / <sub>8</sub> "	2 <sup>3</sup> / <sub>4</sub> "	2 <sup>7</sup> / <sub>8</sub> "	3"

For Top Down-Bottom Up, add <sup>5</sup>/<sub>8</sub>"

CORDLESS LIFT & LOCK - Includes head and bottom rails	48"	60"	72"	84"	108"	120"
Prelude Light Filtering	2 <sup>3</sup> / <sub>4</sub> "	3 <sup>1</sup> / <sub>8</sub> "	3 <sup>3</sup> / <sub>8</sub> "	3 <sup>5</sup> / <sub>8</sub> "	3 <sup>7</sup> / <sub>8</sub> "	4 <sup>1</sup> / <sub>8</sub> "
Prelude Blackout	2 <sup>1</sup> / <sub>4</sub> "	2 <sup>1</sup> / <sub>2</sub> "	2 <sup>5</sup> / <sub>8</sub> "	2 <sup>3</sup> / <sub>4</sub> "	2 <sup>7</sup> / <sub>8</sub> "	3"

For Top Down-Bottom Up, add 1<sup>1</sup>/<sub>4</sub>"

OVATION	84"	96"	108"	120"
Prelude	6 <sup>1</sup> / <sub>2</sub> "	7 <sup>1</sup> / <sub>4</sub> "	8"	8 <sup>3</sup> / <sub>4</sub> "

Ovations minimum fabric stack measures 6<sup>1</sup>/<sub>2</sub>" regardless of the ordered width. Fabric stacking dimensions are determined by the slider's hardware, not ordered width.

### Cellular Shade Pricing Examples

#### Rechargeable Simplicity Pricing Example:

Linen Weave	
Light Filtering 42" x 60" Shade:	\$422.00
Simplicity Rechargeable Motor Surcharge:	\$368.00
Charger for Rechargeable:	\$30.00
Simplicity Remote Control:	\$44.00
<b>Total List Price:</b>	<b>\$864.00</b>

#### Motorized Top Down-Bottom Up Pricing Example:

Linen Weave	
Light Filtering 42" x 60" Shade:	\$422.00
Simplicity Rechargeable TDBU Surcharge:	\$589.00
Charger for Rechargeable:	\$30.00
TDBU Remote Control:	\$72.00
<b>Total List Price:</b>	<b>\$1413.00</b>

#### Cordless Ultra Simplicity Pricing Example:

Linen Weave	
Light Filtering 42" x 60" Shade:	\$422.00
Cordless Ultra Surcharge:	\$88.00
Scotchgard:	\$38.00
<b>Total List Price:</b>	<b>\$548.00</b>

#### Simplicity Motorization Pricing Example:

Linen Weave	
Light Filtering 42" x 60" Shade:	\$422.00
Simplicity Motor Surcharge:	\$368.00
Simplicity Remote Control:	\$44.00
<b>Total List Price:</b>	<b>\$834.00</b>

#### Prelude Motorized Top Down-Bottom Up Pricing Example:

Linen Weave	
Light Filtering 42" x 60" Shade:	\$422.00
Simplicity Rechargeable	
TDBU Surcharge:	\$589.00
Charger for Rechargeable:	\$30.00
TDBU Remote Control:	\$72.00
<b>Total List Price:</b>	<b>\$1113.00</b>

#### Odysee Cellular Blind Motorized Pricing Example:

Light Filtering 42" x 60" Shade:	\$702.00
Simplicity Rechargeable	
Motor Surcharge:	\$319.00
Charger for Rechargeable:	\$28.00
Simplicity Remote Control:	\$41.00
<b>Total List Price:</b>	<b>\$1090.00</b>

# Cellular Shade Collection

## HARDWARE UPGRADE OPTIONS

STANDARD RECTANGULAR

LIFT SYSTEM	UPGRADES	ADD
Cord Lock	Top Down-Bottom Up	\$68
Cordless Lift & Lock	Bottom Up	No extra charge
	Top Down-Bottom Up	\$88
Cordless Ultra	Bottom Up	\$88
	Top Down-Bottom Up	\$176
Cord Loop	Bottom Up	\$88
	Top Down-Bottom Up	\$176

DESIGNER UPGRADE OPTIONS	UPGRADES	ADD
Add to Any Lift System Upgrade (Chart to the left)	Metallic Hardware <i>Does not apply to pricing grids 1 &amp; 2</i>	\$24
	Fabric Wrapped Hardware <i>Does not apply to pricing grids 1 &amp; 2</i>	\$24
	Scotchgard Stain Protection	\$38
	Highlights Valance <i>See Page 116 For More Information</i>	
Slumbershade Light Blocking Sidetrack System	Insulating SlumberShades <i>See Page 69 For More Information</i>	\$142

ADDITIONAL OPTIONS	UPGRADES	ADD
Add to Any Upgrade Above	Two-On-One Head Rail	\$52 Add to Cord Lock Shade and add lift system upgrade
	Three-On-One Head Rail	\$105 Add to Cord Lock Shade and add lift system upgrade (Prelude Only)
	Cut Outs	\$55 Per side
	Day-Night	Price each separate shade then add together
Other	Soprano - Two Moving Rails	\$136
	Ovation Center Stack	\$88
Accessories	6 Foot Expandable Pole	\$44
	12 Foot Expandable Pole	\$54

## Cellular Shade Motorized Hardware Upgrade Options

MOTORIZED	UPGRADES	ADD	
PowerTouch Rechargeable Motorization System	Rechargeable Integrated Battery Pack	\$132	For More Information Page 65
	Plug-In Charger for Rechargeable Li-Ion	\$30	
Simplicity Motorization System (non-rechargeable)	Motor and Battery Wand	\$368	For More Information Page 55
	48" Extension Wire	\$20	
	Single Unit DC Power Supply/Transformer	\$80	
Simplicity Integrated Rechargeable Motorization System	Motor and Integrated Battery Pack	\$368	For More Information Page 57
	Plug-In Charger for Rechargeable Li-Ion	\$30	
	Top Down-Bottom Up*	\$589	
	7.4v Solar Panel & Mounting Brackets	\$110	
Simplicity Systems Controllers	NEO Controller	\$363	For More Information Pages 64, 55 & 57
	NEO Application for Mobile Devices	FREE	
	Simplicity 5 Channel Remote	\$44	
	Simplicity 6 Channel Remote with Timer	\$72	
	Simplicity 14 Channel White Remote **	\$72	
EZ Charge Extension Wand 7.4V Rechargeable Motors	Wall Mount Receiver Kit 7.4V	\$22	For More Information Page 62
	Extendable Wand 7.4V	\$40	
Low Voltage Hardwiring 12V	9 Channel Wall Mount Transformer 12V	\$285	For More Information Page 63

\*Upcharge includes motorization plus second motor and Top Down-Bottom Up components

\*\* TDBU Remote required for Motorized Top Down-Bottom Up shades

**Cellular Shade Collection**  
**PRICING**

**Boutique 3/4" Light Filtering**  
**Linen Weave 3/4" Light Filtering**  
**Verona 3/4" Light Filtering**  
**Aspen 3/8" Double Cell Light Filtering**

**PRICE GROUP 1~**  
**Cord Lock**  
**Cordless Lift & Lock**

		Width In Inches														
		24	30	36	42	48	54	60	66	72	84	96	108	120	132	144
Length In Inches	36	231	254	288	320	349	379	409	435	466	532	595	658	726	788	852
	42	245	278	308	345	379	412	447	478	512	585	655	727	805	883	962
	48	257	296	334	370	409	446	481	521	558	649	738	827	917	1006	1095
	54	275	312	354	394	437	477	527	576	627	727	827	928	1027	1128	1229
	60	291	333	379	422	465	527	582	637	693	805	916	1027	1140	1251	1362
	66	303	349	401	455	515	576	637	699	760	883	1006	1128	1251	1373	1496
	72	320	366	422	493	560	627	693	760	827	962	1095	1229	1362	1496	1629
	78	334	388	459	532	604	677	750	822	894	1039	1184	1328	1473	1619	1763
	84	343	415	493	572	649	727	805	883	962	1116	1273	1429	1585	1740	1896
	90	358	443	527	610	693	778	861	944	1027	1195	1362	1528	1696	1863	2030
	96	382	471	560	649	738	827	916	1006	1095	1273	1451	1629	1807	1985	2163
	108	426	527	627	727	827	928	1027	1128	1229	1429	1629	1829	2030	2230	2431
120	471	582	693	805	916	1027	1140	1249	1362	1585	1806	2030	2252	2476	2698	

Cord Loop Hardware is recommended on sizes within the shaded area.  
Motorized Lift Systems are not offered within the shaded area.

Widths over 108" will be built as Two-On-One Shades.

**STANDARD RECTANGULAR**

LIFT SYSTEM AND DESIGN UPGRADES			ADD
<b>Cord Lock</b>	Top Down-Bottom Up		\$68
<b>Cordless Lift &amp; Lock</b>	Bottom Up		No Charge
	Top Down-Bottom Up		\$88
<b>Cordless Ultra</b>	Bottom Up		\$88
	Top Down-Bottom Up		\$176
<b>Cord Loop</b>	Bottom Up		\$88
	Top Down-Bottom Up		\$176
DESIGNER UPGRADE OPTIONS (Add to any Lift System Upgrade Above)			ADD
No extra charge on these fabrics for Fabric Wrap and Metallic Hardware			\$0
Scotchgard Stain Protection			\$38
MOTORIZATION*			MORE INFO
PowerTouch Rechargeable			Pg 65 \$132
Simplicity - Motor and Battery Wand			Pg 55 \$368
Simplicity Rechargeable Motorization - Motor with Integrated Battery			Pg 57 \$368
Plug-In Charger for Li-Ion Battery Pack (used for PowerTouch and Simplicity Rechargeable and is required)			Pg 59 \$30
Simplicity 5 Channel Remote			Pg 59 \$44
Simplicity 6 Channel Remote with Timer			Pg 59 \$72
Simplicity 14 Channel White Remote			Pg 61 \$72
Simplicity Smart Controller (NEO)			Pg 64 \$363
Top Down-Bottom Up Motorization and Solar Charge Option Pricing			Pg 10
<b>EZ Charge Extension Wand</b>	Wall Mount Receiver Kit 7.4V	\$22	For More Information Page 62
	Extendable Wand 7.4V	\$40	
<b>Low Voltage Hardwiring</b>	9 Channel Wall Mount Hardwired Transformer 12V	\$285	For More Information Page 63
ADDITIONAL OPTIONS			MORE INFO
For additional options and surcharges refer to page 10.			Pg 10

\*Motorized Pricing Examples pages 10, 51, 55 and 58  
~Includes Fabric Wrapped Hardware



**Cellular Shade Collection**  
**PRICING**

**Boutique 3/4" Room Darkening**  
**Linen Weave 3/4" Room Darkening**  
**Verona 3/4" Room Darkening**

**PRICE GROUP 2~**  
**Cord Lock**  
**Cordless Lift & Lock**

STANDARD RECTANGULAR

		Width In Inches														
		24	30	36	42	48	54	60	66	72	84	96	108	120	132	144
Length In Inches	36	301	331	375	416	454	493	532	566	606	692	774	856	994	1075	1158
	42	319	362	401	449	493	536	582	622	666	761	852	946	1097	1198	1301
	48	335	385	435	481	532	580	626	678	726	844	960	1076	1243	1358	1474
	54	358	406	461	513	569	621	686	749	816	946	1076	1207	1386	1517	1648
	60	379	433	493	549	605	686	757	829	901	1047	1191	1336	1532	1677	1821
	66	394	454	522	592	670	749	829	909	988	1148	1308	1467	1677	1835	1995
	72	416	476	549	641	728	816	901	988	1076	1251	1424	1598	1821	1995	2168
	78	435	505	597	692	786	881	975	1069	1163	1351	1540	1727	1965	2155	2342
	84	446	540	641	744	844	946	1047	1148	1251	1451	1655	1858	2111	2312	2515
	90	466	576	686	793	901	1012	1120	1228	1336	1554	1771	1987	2255	2472	2689
	96	497	613	728	844	960	1076	1191	1308	1424	1655	1887	2118	2400	2631	2862
108	554	686	816	946	1076	1207	1336	1467	1598	1858	2118	2378	2689	2949	3211	
120	613	757	901	1047	1191	1336	1482	1624	1771	2061	2348	2639	2978	3269	3558	

■ Cord Loop Hardware is recommended on sizes within the shaded area.  
Motorized Lift Systems are not offered within the shaded area.

Widths over 108" will be built as Two-On-One Shades.

LIFT SYSTEM AND DESIGN UPGRADES			ADD
<b>Cord Lock</b>	Top Down-Bottom Up		\$68
<b>Cordless Lift &amp; Lock</b>	Bottom Up		No Charge
	Top Down-Bottom Up		\$88
<b>Cordless Ultra</b>	Bottom Up		\$88
	Top Down-Bottom Up		\$176
<b>Cord Loop</b>	Bottom Up		\$88
	Top Down-Bottom Up		\$176
DESIGNER UPGRADE OPTIONS (Add to any Lift System Upgrade Above)			ADD
No extra charge on these fabrics for Fabric Wrap and Metallic Hardware			\$0
Scotchgard Stain Protection			\$38
MOTORIZATION*			MORE INFO
PowerTouch Rechargeable			Pg 65
Simplicity - Motor and Battery Wand			Pg 55
Simplicity Rechargeable Motorization - Motor with Integrated Battery			Pg 57
Plug-In Charger for Li-Ion Battery Pack (used for PowerTouch and Simplicity Rechargeable and is required)			Pg 59
Simplicity 5 Channel Remote			Pg 59
Simplicity 6 Channel Remote with Timer			Pg 59
Simplicity 14 Channel White Remote			Pg 61
Simplicity Smart Controller (NEO)			Pg 64
Top Down-Bottom Up Motorization and Solar Charge Option Pricing			Pg 10
<b>EZ Charge Extension Wand</b>	Wall Mount Receiver Kit 7.4V	\$22	For More Information Page 62
	Extendable Wand 7.4V	\$40	
<b>Low Voltage Hardwiring</b>	9 Channel Wall Mount Hardwired Transformer 12V	\$285	For More Information Page 63
ADDITIONAL OPTIONS			MORE INFO
For additional options and surcharges refer to page 10.			Pg 10

\*Motorized Pricing Examples pages 10, 51, 55 and 58  
-Includes Fabric Wrapped Hardware

**Cellular Shade Collection**  
**PRICING**

**Premiere 1/2" Light Filtering**

**PRICE GROUP 3**  
**Cord Lock**  
**Cordless Lift & Lock**

		Width In Inches														
		24	30	36	42	48	54	60	66	72	84	96	108	120	132	144
Length In Inches	36	153	171	196	219	241	263	285	305	328	377	424	470	521	567	614
	42	164	189	211	238	263	288	314	337	362	416	468	522	579	637	696
	48	173	202	230	257	285	313	339	369	396	464	530	596	663	729	795
	54	186	214	245	274	306	336	373	410	447	522	596	670	744	819	894
	60	198	229	263	295	327	373	414	455	497	579	662	744	828	910	993
	66	207	241	280	319	365	410	455	501	546	637	729	819	910	1000	1092
	72	219	253	295	348	398	447	497	546	596	696	795	894	993	1092	1191
	78	230	270	323	377	431	484	538	592	645	753	861	967	1075	1183	1290
	84	237	290	348	406	464	522	579	637	696	810	927	1042	1158	1273	1389
	90	248	311	373	435	497	559	621	682	744	868	993	1116	1240	1364	1488
	96	266	332	398	464	530	596	662	729	795	927	1059	1191	1323	1455	1587
	108	299	373	447	522	596	670	744	819	894	1042	1191	1339	1488	1636	1786
120	332	414	497	579	662	744	828	909	993	1158	1322	1488	1653	1819	1984	

 Cord Loop Hardware is recommended on sizes within the shaded area.  
Motorized Lift Systems are not offered within the shaded area.

Widths over 108" will be built as Two-On-One Shades.

STANDARD RECTANGULAR

LIFT SYSTEM AND DESIGN UPGRADES			ADD
<b>Cord Lock</b>	Top Down-Bottom Up		\$68
<b>Cordless Lift &amp; Lock</b>	Bottom Up		No Charge
	Top Down-Bottom Up		\$88
<b>Cordless Ultra</b>	Bottom Up		\$88
	Top Down-Bottom Up		\$176
<b>Cord Loop</b>	Bottom Up		\$88
	Top Down-Bottom Up		\$176
DESIGNER UPGRADE OPTIONS (Add to any Lift System Upgrade Above)			ADD
Metallic Hardware or Fabric Wrapped Hardware			\$24
Scotchgard Stain Protection			\$38
MOTORIZATION*			MORE INFO
PowerTouch Rechargeable			Pg 65 \$132
Simplicity - Motor and Battery Wand			Pg 55 \$368
Simplicity Rechargeable Motorization - Motor with Integrated Battery			Pg 57 \$368
Plug-In Charger for Li-Ion Battery Pack (used for PowerTouch and Simplicity Rechargeable and is required)			Pg 59 \$30
Simplicity 5 Channel Remote			Pg 59 \$44
Simplicity 6 Channel Remote with Timer			Pg 59 \$72
Simplicity 14 Channel White Remote			Pg 61 \$72
Simplicity Smart Controller (NEO)			Pg 64 \$363
Top Down-Bottom Up Motorization and Solar Charge Option Pricing			Pg 10
<b>EZ Charge Extension Wand</b>	Wall Mount Receiver Kit 7.4V	\$22	For More Information Page 62
	Extendable Wand 7.4V	\$40	
<b>Low Voltage Hardwiring</b>	9 Channel Wall Mount Hardwired Transformer 12V	\$285	For More Information Page 63
ADDITIONAL OPTIONS		MORE INFO	
Prints & Custom Graphics		Add 20% - Includes Anna Cote, Gradients, Spheres, Tuscan Scroll and Custom Graphics	
For additional options and surcharges refer to page 10.		Pg 10	

\*Motorized Pricing Examples pages 10, 51, 55 and 58

**Cellular Shade Collection**  
**PRICING**

**Premiere 1/2" Blackout**

**PRICE GROUP 4**  
**Cord Lock**  
**Cordless Lift & Lock**

STANDARD RECTANGULAR

		Width In Inches														
		24	30	36	42	48	54	60	66	72	84	96	108	120	132	144
Length In Inches	36	199	223	255	285	314	342	371	397	427	491	552	611	678	738	799
	42	214	246	275	310	342	375	409	439	471	541	609	679	753	829	905
	48	225	263	299	335	371	407	441	480	515	604	689	775	862	948	1034
	54	242	279	319	357	398	437	485	533	582	679	775	871	968	1065	1163
	60	258	298	342	384	426	485	539	592	647	753	861	968	1077	1183	1291
	66	270	314	364	415	475	533	592	652	710	829	948	1065	1183	1300	1420
	72	285	329	384	453	518	582	647	710	775	905	1034	1163	1291	1420	1549
	78	299	351	420	491	561	630	700	770	839	979	1120	1258	1398	1538	1677
	84	309	377	453	528	604	679	753	829	905	1053	1206	1355	1506	1655	1806
	90	323	405	485	566	647	727	808	887	968	1129	1291	1451	1612	1774	1935
	96	346	432	518	604	689	775	861	948	1034	1206	1377	1549	1720	1892	2064
	108	389	485	582	679	775	871	968	1065	1163	1355	1549	1741	1935	2127	2322
120	432	539	647	753	861	968	1077	1182	1291	1506	1719	1935	2149	2365	2580	

■ Cord Loop Hardware is recommended on sizes within the shaded area.  
Motorized Lift Systems are not offered within the shaded area.

Widths over 108" will be built as Two-On-One Shades.

LIFT SYSTEM AND DESIGN UPGRADES			ADD
Cord Lock	Top Down-Bottom Up		\$68
Cordless Lift & Lock	Bottom Up		No Charge
	Top Down-Bottom Up		\$88
Cordless Ultra	Bottom Up		\$88
	Top Down-Bottom Up		\$176
Cord Loop	Bottom Up		\$88
	Top Down-Bottom Up		\$176
DESIGNER UPGRADE OPTIONS (Add to any Lift System Upgrade Above)			ADD
Metallic Hardware or Fabric Wrapped Hardware			\$24
Scotchgard Stain Protection			\$38
MOTORIZATION*			MORE INFO
PowerTouch Rechargeable			Pg 65 \$132
Simplicity - Motor and Battery Wand			Pg 55 \$368
Simplicity Rechargeable Motorization - Motor with Integrated Battery			Pg 57 \$368
Plug-In Charger for Li-Ion Battery Pack (used for PowerTouch and Simplicity Rechargeable and is required)			Pg 59 \$30
Simplicity 5 Channel Remote			Pg 59 \$44
Simplicity 6 Channel Remote with Timer			Pg 59 \$72
Simplicity 14 Channel White Remote			Pg 61 \$72
Simplicity Smart Controller (NEO)			Pg 64 \$363
Top Down-Bottom Up Motorization and Solar Charge Option Pricing			Pg 10
EZ Charge Extension Wand	Wall Mount Receiver Kit 7.4V	\$22	For More Information Page 62
	Extendable Wand 7.4V	\$40	
Low Voltage Hardwiring	9 Channel Wall Mount Hardwired Transformer 12V	\$285	For More Information Page 63
ADDITIONAL OPTIONS			MORE INFO
Prints & Custom Graphics			Add 20% - Includes Anna Cote, Gradients, Spheres, Tuscan Scroll, Homespun, Florance, Strata, Blossom, Country Woven and Custom Graphics
For additional options and surcharges refer to page 10.			Pg 10

\*Motorized Pricing Examples pages 10, 51, 55 and 58

**Cellular Shade Collection**  
**PRICING**

**Premiere 3/4" Light Filtering**

**PRICE GROUP 5**  
**Cord Lock**  
**Cordless Lift & Lock**

		Width In Inches														
		24	30	36	42	48	54	60	66	72	84	96	108	120	132	144
Length In Inches	36	169	189	216	241	266	290	314	336	361	415	467	517	574	624	676
	42	181	208	233	262	290	317	346	371	399	458	515	575	637	701	766
	48	191	223	253	283	314	345	373	406	436	511	583	656	730	802	875
	54	205	236	270	302	337	370	411	451	492	575	656	737	819	901	984
	60	218	252	290	325	360	411	456	501	547	637	729	819	911	1001	1093
	66	228	266	308	351	402	451	501	552	601	701	802	901	1001	1100	1202
	72	241	279	325	383	438	492	547	601	656	766	875	984	1093	1202	1311
	78	253	297	356	415	475	533	592	652	710	829	948	1064	1183	1302	1419
	84	261	319	383	447	511	575	637	701	766	891	1020	1147	1274	1401	1528
	90	273	343	411	479	547	615	684	751	819	955	1093	1228	1364	1501	1637
	96	293	366	438	511	583	656	729	802	875	1020	1165	1311	1456	1601	1746
	108	329	411	492	575	656	737	819	901	984	1147	1311	1473	1637	1800	1965
120	366	456	547	637	729	819	911	1000	1093	1274	1455	1637	1819	2001	2183	

 Cord Loop Hardware is recommended on sizes within the shaded area.  
Motorized Lift Systems are not offered within the shaded area.

Widths over 108" will be built as Two-On-One Shades.

STANDARD RECTANGULAR

LIFT SYSTEM AND DESIGN UPGRADES			ADD
<b>Cord Lock</b>	Top Down-Bottom Up		\$68
<b>Cordless Lift &amp; Lock</b>	Bottom Up		No Charge
	Top Down-Bottom Up		\$88
<b>Cordless Ultra</b>	Bottom Up		\$88
	Top Down-Bottom Up		\$176
<b>Cord Loop</b>	Bottom Up		\$88
	Top Down-Bottom Up		\$176
DESIGNER UPGRADE OPTIONS (Add to any Lift System Upgrade Above)			ADD
Metallic Hardware or Fabric Wrapped Hardware			\$24
Scotchgard Stain Protection			\$38
MOTORIZATION*			MORE INFO
PowerTouch Rechargeable			Pg 65 \$132
Simplicity - Motor and Battery Wand			Pg 55 \$368
Simplicity Rechargeable Motorization - Motor with Integrated Battery			Pg 57 \$368
Plug-In Charger for Li-Ion Battery Pack (used for PowerTouch and Simplicity Rechargeable and is required)			Pg 59 \$30
Simplicity 5 Channel Remote			Pg 59 \$44
Simplicity 6 Channel Remote with Timer			Pg 59 \$72
Simplicity 14 Channel White Remote			Pg 61 \$72
Simplicity Smart Controller (NEO)			Pg 64 \$363
Top Down-Bottom Up Motorization and Solar Charge Option Pricing			Pg 10
<b>EZ Charge Extension Wand</b>	Wall Mount Receiver Kit 7.4V	\$22	For More Information Page 62
	Extendable Wand 7.4V	\$40	
<b>Low Voltage Hardwiring</b>	9 Channel Wall Mount Hardwired Transformer 12V	\$285	For More Information Page 63
ADDITIONAL OPTIONS		MORE INFO	
Prints & Custom Graphics		Add 20% - Includes Anna Cote, Gradients, Spheres, Tuscan Scroll and Custom Graphics	
For additional options and surcharges refer to page 10.		Pg 10	

\*Motorized Pricing Examples pages 10, 51, 55 and 58

**Cellular Shade Collection**  
**PRICING**

**Premiere 3/4" Karma-Light Room Darkening & Blackout**

**PRICE GROUP 6**  
**Cord Lock**  
**Cordless Lift & Lock**

STANDARD RECTANGULAR

		Width In Inches														
		24	30	36	42	48	54	60	66	72	84	96	108	120	132	144
Length In Inches	36	220	246	281	314	346	377	409	437	470	540	608	673	747	812	879
	42	236	271	303	341	377	413	450	483	519	596	670	748	829	912	996
	48	249	290	329	368	409	449	485	528	567	665	758	853	949	1043	1138
	54	267	307	351	393	439	481	535	587	640	748	853	959	1065	1172	1280
	60	284	328	377	423	468	535	593	652	712	829	948	1065	1185	1302	1421
	66	297	346	401	457	523	587	652	718	782	912	1043	1172	1302	1430	1563
	72	314	363	423	498	570	640	712	782	853	996	1138	1280	1421	1563	1705
	78	329	387	463	540	618	693	770	848	923	1078	1233	1384	1538	1693	1845
	84	340	415	498	582	665	748	829	912	996	1159	1326	1492	1657	1822	1987
	90	355	446	535	623	712	800	890	977	1065	1242	1421	1597	1774	1952	2129
	96	381	476	570	665	758	853	948	1043	1138	1326	1515	1705	1893	2082	2270
108	428	535	640	748	853	959	1065	1172	1280	1492	1705	1915	2129	2340	2555	
120	476	593	712	829	948	1065	1185	1300	1421	1657	1892	2129	2365	2602	2838	

Cord Loop Hardware is recommended on sizes within the shaded area. Motorized Lift Systems are not offered within the shaded area.

Widths over 108" will be built as Two-On-One Shades.

LIFT SYSTEM AND DESIGN UPGRADES			ADD
<b>Cord Lock</b>	Top Down-Bottom Up		\$68
<b>Cordless Lift &amp; Lock</b>	Bottom Up		No Charge
	Top Down-Bottom Up		\$88
<b>Cordless Ultra</b>	Bottom Up		\$88
	Top Down-Bottom Up		\$176
<b>Cord Loop</b>	Bottom Up		\$88
	Top Down-Bottom Up		\$176
DESIGNER UPGRADE OPTIONS (Add to any Lift System Upgrade Above)			ADD
Metallic Hardware or Fabric Wrapped Hardware			\$24
Scotchgard Stain Protection			\$38
MOTORIZATION*			MORE INFO
PowerTouch Rechargeable			Pg 65 \$132
Simplicity - Motor and Battery Wand			Pg 55 \$368
Simplicity Rechargeable Motorization - Motor with Integrated Battery			Pg 57 \$368
Plug-In Charger for Li-Ion Battery Pack (used for PowerTouch and Simplicity Rechargeable and is required)			Pg 59 \$30
Simplicity 5 Channel Remote			Pg 59 \$44
Simplicity 6 Channel Remote with Timer			Pg 59 \$72
Simplicity 14 Channel White Remote			Pg 61 \$72
Simplicity Smart Controller (NEO)			Pg 64 \$363
Top Down-Bottom Up Motorization and Solar Charge Option Pricing			Pg 10
<b>EZ Charge Extension Wand</b>	Wall Mount Receiver Kit 7.4V	\$22	For More Information Page 62
	Extendable Wand 7.4V	\$40	
<b>Low Voltage Hardwiring</b>	9 Channel Wall Mount Hardwired Transformer 12V	\$285	For More Information Page 63
ADDITIONAL OPTIONS			MORE INFO
Prints & Custom Graphics			Add 20% - Includes Anna Cote, Gradients, Spheres, Tuscan Scroll, Homespun, Florance, Strata, Blossom, Country Woven and Custom Graphics
For additional options and surcharges refer to page 10.			Pg 10

\*Motorized Pricing Examples pages 10, 51, 55 and 58

**Cellular Shade Collection**  
**PRICING**

**Debut 1/2" Single Cell**

**PRICE GROUP 7**  
**Cord Lock**  
**Cordless Lift & Lock**

		Width In Inches														
		24	30	36	42	48	54	60	66	72	84	96	108	120	132	144
Length In Inches	36	146	163	187	209	230	251	272	291	313	360	405	449	497	541	586
	42	157	180	201	227	251	275	300	322	346	397	447	498	553	608	664
	48	165	193	220	245	272	299	324	352	378	443	506	569	633	696	759
	54	178	204	234	262	292	321	356	391	427	498	569	640	710	782	853
	60	189	219	251	282	312	356	395	434	474	553	632	710	790	869	948
	66	198	230	267	305	348	391	434	478	521	608	696	782	869	955	1042
	72	209	242	282	332	380	427	474	521	569	664	759	853	948	1042	1137
	78	220	258	308	360	411	462	514	565	616	719	822	923	1026	1129	1231
	84	226	277	332	388	443	498	553	608	664	773	885	995	1105	1215	1326
	90	237	297	356	415	474	534	593	651	710	829	948	1065	1184	1302	1420
	96	254	317	380	443	506	569	632	696	759	885	1011	1137	1263	1389	1515
108	285	356	427	498	569	640	710	782	853	995	1137	1278	1420	1562	1705	
120	317	395	474	553	632	710	790	868	948	1105	1262	1420	1578	1736	1894	

Widths over 108" will be built as Two-On-One Shades.

**STANDARD RECTANGULAR**

<b>LIFT SYSTEM AND DESIGN UPGRADES</b>			<b>ADD</b>
<b>Cord Lock</b>	Top Down-Bottom Up		\$68
<b>Cordless Lift &amp; Lock</b>	Bottom Up		No Charge
	Top Down-Bottom Up		\$88
<b>Cordless Ultra</b>	Bottom Up		\$88
	Top Down-Bottom Up		\$176
<b>Cord Loop</b>	Bottom Up		\$88
	Top Down-Bottom Up		\$176
<b>DESIGNER UPGRADE OPTIONS (Add to any Lift System Upgrade Above)</b>			<b>ADD</b>
Metallic Hardware or Fabric Wrapped Hardware			\$24
Scotchgard Stain Protection			\$38
<b>MOTORIZATION*</b>			<b>MORE INFO</b>
PowerTouch Rechargeable			Pg 65 \$132
Simplicity - Motor and Battery Wand			Pg 55 \$368
Simplicity Rechargeable Motorization - Motor with Integrated Battery			Pg 57 \$368
Plug-In Charger for Li-Ion Battery Pack (used for PowerTouch and Simplicity Rechargeable and is required)			Pg 59 \$30
Simplicity 5 Channel Remote			Pg 59 \$44
Simplicity 6 Channel Remote with Timer			Pg 59 \$72
Simplicity 14 Channel White Remote			Pg 61 \$72
Simplicity Smart Controller (NEO)			Pg 64 \$363
Top Down-Bottom Up Motorization and Solar Charge Option Pricing			Pg 10
<b>EZ Charge Extension Wand</b>	Wall Mount Receiver Kit 7.4V	\$22	For More Information Page 62
	Extendable Wand 7.4V	\$40	
<b>Low Voltage Hardwiring</b>	9 Channel Wall Mount Hardwired Transformer 12V	\$285	For More Information Page 63
<b>ADDITIONAL OPTIONS</b>		<b>MORE INFO</b>	
Prints & Custom Graphics		Add 20% - Includes Homespun, Country Woven, Florance, Strata, Angel Hair, Blossom, Strie and Terrazzo.	
For additional options and surcharges refer to page 10.		Pg 10	

\*Motorized Pricing Examples pages 10, 51, 55 and 58

Cellular Shade Collection

PRICING

Debut 3/4" Single Cell  
Debut 1/2" Double Cell

**PRICE GROUP 8**  
**Cord Lock**  
**Cordless Lift & Lock**

STANDARD RECTANGULAR

Width In Inches

	24	30	36	42	48	54	60	66	72	84	96	108	120	132	144
36	161	180	206	230	253	277	300	321	345	396	446	494	547	596	645
42	173	198	222	250	277	303	330	355	381	437	492	548	609	669	731
48	182	213	242	270	300	329	357	388	416	488	557	626	697	766	835
54	196	225	258	289	322	354	392	431	470	548	626	704	781	861	939
60	208	241	277	311	344	392	435	478	522	609	696	781	869	956	1043
66	218	253	294	336	383	431	478	526	574	669	766	861	956	1051	1147
72	230	267	311	366	418	470	522	574	626	731	835	939	1043	1147	1251
78	242	284	339	396	453	509	566	622	678	791	905	1016	1129	1242	1355
84	249	305	366	427	488	548	609	669	731	851	974	1095	1216	1337	1459
90	261	327	392	457	522	588	653	717	781	912	1043	1172	1303	1433	1562
96	280	349	418	488	557	626	696	766	835	974	1113	1251	1390	1528	1667
108	314	392	470	548	626	704	781	861	939	1095	1251	1406	1562	1719	1876
120	349	435	522	609	696	781	869	955	1043	1216	1389	1562	1736	1910	2084

Widths over 108" will be built as Two-On-One Shades.

LIFT SYSTEM AND DESIGN UPGRADES		ADD
Cord Lock	Top Down-Bottom Up	\$68
Cordless Lift & Lock	Bottom Up	No Charge
	Top Down-Bottom Up	\$88
Cordless Ultra	Bottom Up	\$88
	Top Down-Bottom Up	\$176
Cord Loop	Bottom Up	\$88
	Top Down-Bottom Up	\$176
DESIGNER UPGRADE OPTIONS (Add to any Lift System Upgrade Above)		ADD
Metallic Hardware or Fabric Wrapped Hardware		\$24
Scotchgard Stain Protection		\$38
MOTORIZATION*		MORE INFO
PowerTouch Rechargeable		Pg 65 \$132
Simplicity - Motor and Battery Wand		Pg 55 \$368
Simplicity Rechargeable Motorization - Motor with Integrated Battery		Pg 57 \$368
Plug-In Charger for Li-Ion Battery Pack (used for PowerTouch and Simplicity Rechargeable and is required)		Pg 59 \$30
Simplicity 5 Channel Remote		Pg 59 \$44
Simplicity 6 Channel Remote with Timer		Pg 59 \$72
Simplicity 14 Channel White Remote		Pg 61 \$72
Simplicity Smart Controller (NEO)		Pg 64 \$363
Top Down-Bottom Up Motorization and Solar Charge Option Pricing		Pg 10
EZ Charge Extension Wand	Wall Mount Receiver Kit 7.4V	\$22
	Extendable Wand 7.4V	\$40
Low Voltage Hardwiring	9 Channel Wall Mount Hardwired Transformer 12V	\$285
		For More Information Page 62
		For More Information Page 63
ADDITIONAL OPTIONS		MORE INFO
Prints & Custom Graphics		Add 20% - Includes Homespun, Country Woven, Florance, Strata, Angel Hair, Blossom, Strie and Terrazzo.
For additional options and surcharges refer to page 10.		Pg 10

\*Motorized Pricing Examples pages 10, 51, 55 and 58  
\*\* TDBU Rechargeable Only

**Cellular Shade Collection**  
**PRICING**

**Symphony 3/8" Light Filtering**

**PRICE GROUP 9**  
**Cord Lock**  
**Cordless Lift & Lock**

Length In Inches	Width In Inches														
	24	30	36	42	48	54	60	66	72	84	96	108	120	132	144
36	141	158	181	201	223	242	263	281	302	347	390	434	480	523	567
42	151	173	194	219	242	264	289	310	334	383	431	481	534	587	641
48	160	185	212	237	263	288	313	340	366	427	488	549	610	671	732
54	172	196	225	253	282	310	344	378	412	481	549	617	686	755	823
60	182	211	242	271	301	344	382	419	458	534	610	686	763	839	915
66	191	223	257	294	336	378	419	462	504	587	671	755	839	922	1006
72	201	233	271	321	366	412	458	504	549	641	732	823	915	1006	1098
78	212	249	298	347	397	446	496	545	595	694	793	892	991	1090	1189
84	218	267	321	374	427	481	534	587	641	747	854	961	1067	1174	1280
90	228	286	344	401	458	515	572	629	686	801	915	1029	1143	1258	1372
96	245	305	366	427	488	549	610	671	732	854	975	1097	1220	1341	1463
108	275	344	412	481	549	617	686	755	823	961	1097	1234	1372	1509	1646
120	305	382	458	534	610	686	763	838	915	1067	1219	1372	1524	1677	1829

 Cord Loop Hardware is recommended on sizes within the shaded area.  
Motorized Lift Systems are not offered within the shaded area.

Widths over 108" will be built as Two-On-One Shades.

STANDARD RECTANGULAR

FABRIC SURCHARGES			ADD
Prints and Duotones			20%
Flame Resistant 3/8" double cell			30%
Flame Resistant 3/4" single cell			30%
LIFT SYSTEM AND DESIGN UPGRADES			ADD
<b>Cord Lock</b>	Top Down-Bottom Up		\$68
<b>Cordless Lift &amp; Lock</b>	Bottom Up		No Charge
	Top Down-Bottom Up		\$88
<b>Cordless Ultra</b>	Bottom Up		\$88
	Top Down-Bottom Up		\$176
<b>Cord Loop</b>	Bottom Up		\$88
	Top Down-Bottom Up		\$176
DESIGNER UPGRADE OPTIONS (Add to any Lift System Upgrade Above)			ADD
Metallic Hardware or Fabric Wrapped Hardware			\$24
Scotchgard Stain Protection			\$38
MOTORIZATION*			MORE INFO
PowerTouch Rechargeable			Pg 65 \$132
Simplicity - Motor and Battery Wand			Pg 55 \$368
Simplicity Rechargeable Motorization - Motor with Integrated Battery			Pg 57 \$368
Plug-In Charger for Li-Ion Battery Pack (used for PowerTouch and Simplicity Rechargeable and is required)			Pg 59 \$30
Simplicity 5 Channel Remote			Pg 59 \$44
Simplicity 6 Channel Remote with Timer			Pg 59 \$72
Simplicity 14 Channel White Remote			Pg 61 \$72
Simplicity Smart Controller (NEO)			Pg 64 \$363
Top Down-Bottom Up Motorization and Solar Charge Option Pricing			Pg 10
<b>EZ Charge Extension Wand</b>	Wall Mount Receiver Kit 7.4V	\$22	For More Information Page 62
	Extendable Wand 7.4V	\$40	
<b>Low Voltage Hardwiring</b>	9 Channel Wall Mount Hardwired Transformer 12V	\$285	For More Information Page 63
ADDITIONAL OPTIONS			MORE INFO
For additional options and surcharges refer to page 10.			Pg 10

\*Motorized Pricing Examples pages 10, 51, 55 and 58



**Cellular Shade Collection**  
**PRICING**

**Symphony 3/8" Blackout**

**PRICE GROUP 10**  
**Cord Lock**  
**Cordless Lift & Lock**

STANDARD RECTANGULAR

		Width In Inches														
		24	30	36	42	48	54	60	66	72	84	96	108	120	132	144
Length In Inches	36	184	206	236	262	290	315	342	366	393	452	507	565	624	680	738
	42	197	225	253	285	315	344	376	403	435	498	561	626	695	764	834
	48	208	241	276	309	342	375	407	442	476	556	635	714	793	873	952
	54	224	255	293	329	367	403	448	492	536	626	714	803	892	982	1070
	60	237	275	315	353	392	448	497	545	596	695	793	892	992	1091	1190
	66	249	290	335	383	437	492	545	601	656	764	873	982	1091	1199	1308
	72	262	303	353	418	476	536	596	656	714	834	952	1070	1190	1308	1428
	78	276	324	388	452	517	580	645	709	774	903	1031	1160	1289	1417	1546
	84	284	348	418	487	556	626	695	764	834	972	1111	1250	1388	1527	1664
	90	297	372	448	522	596	670	744	818	892	1042	1190	1338	1486	1636	1784
	96	319	397	476	556	635	714	793	873	952	1111	1268	1427	1586	1744	1902
108	358	448	536	626	714	803	892	982	1070	1250	1427	1605	1784	1962	2140	
120	397	497	596	695	793	892	992	1090	1190	1388	1585	1784	1982	2181	2378	

■ Cord Loop Hardware is recommended on sizes within the shaded area.  
Motorized Lift Systems are not offered within the shaded area.

Widths over 120" will be built as Two-On-One Shades.

LIFT SYSTEM AND DESIGN UPGRADES			ADD
Cord Lock	Top Down-Bottom Up		\$68
Cordless Lift & Lock	Bottom Up		No Charge
	Top Down-Bottom Up		\$88
Cordless Ultra	Bottom Up		\$88
	Top Down-Bottom Up		\$176
Cord Loop	Bottom Up		\$88
	Top Down-Bottom Up		\$176
DESIGNER UPGRADE OPTIONS (Add to any Lift System Upgrade Above)			ADD
Metallic Hardware or Fabric Wrapped Hardware			\$24
Scotchgard Stain Protection			\$38
MOTORIZATION*			MORE INFO
PowerTouch Rechargeable			Pg 65
Simplicity - Motor and Battery Wand			Pg 55
Simplicity Rechargeable Motorization - Motor with Integrated Battery			Pg 57
Plug-In Charger for Li-Ion Battery Pack (used for PowerTouch and Simplicity Rechargeable and is required)			Pg 59
Simplicity 5 Channel Remote			Pg 59
Simplicity 6 Channel Remote with Timer			Pg 59
Simplicity 14 Channel White Remote			Pg 61
Simplicity Smart Controller (NEO)			Pg 64
Top Down-Bottom Up Motorization and Solar Charge Option Pricing			Pg 10
EZ Charge Extension Wand	Wall Mount Receiver Kit 7.4V	\$22	For More Information Page 62
	Extendable Wand 7.4V	\$40	
Low Voltage Hardwiring	9 Channel Wall Mount Hardwired Transformer 12V	\$285	For More Information Page 63
ADDITIONAL OPTIONS			MORE INFO
For additional options and surcharges refer to page 10.			Pg 10

\*Motorized Pricing Examples pages 10, 51, 55 and 58

**Cellular Shade Collection**  
**PRICING**

**Prelude 3/4" Light Filtering**

**PRICE GROUP 11**  
**Cord Lock**  
**Cordless Lift & Lock**

		Width In Inches												
		24	30	36	42	48	54	60	66	72	84	96	108	120
Length In Inches	<b>36</b>	126	140	161	180	198	216	234	250	269	308	347	385	426
	<b>42</b>	135	154	172	195	216	235	257	276	297	341	383	427	474
	<b>48</b>	142	165	189	210	234	256	278	302	324	379	433	487	542
	<b>54</b>	153	175	200	225	251	275	306	335	366	427	487	549	609
	<b>60</b>	162	188	216	242	268	306	339	372	406	474	541	609	677
	<b>66</b>	170	198	229	261	298	335	372	410	447	522	596	670	745
	<b>72</b>	180	207	242	285	325	366	406	447	487	569	650	731	812
	<b>78</b>	189	221	264	308	352	396	441	485	528	616	704	792	880
	<b>84</b>	194	237	285	333	379	427	474	522	569	663	758	853	947
	<b>90</b>	203	254	306	356	406	458	508	558	609	711	812	913	1015
	<b>96</b>	217	271	325	379	433	487	541	596	650	758	866	974	1082
	<b>108</b>	244	306	366	427	487	549	609	670	731	853	974	1096	1217
<b>120</b>	271	339	406	474	541	609	677	744	812	947	1081	1217	1352	

■ Cord Loop Hardware is recommended on sizes within the shaded area.

Motorized lift systems are not offered within the shaded area.

**STANDARD RECTANGULAR**

LIFT SYSTEM AND DESIGN UPGRADES			ADD
<b>Cord Lock</b>	Top Down-Bottom Up		\$68
<b>Cordless Lift &amp; Lock</b>	Bottom Up		No Charge
	Top Down-Bottom Up		\$88
<b>Cordless Ultra</b>	Bottom Up		\$88
	Top Down-Bottom Up		\$176
<b>Cord Loop</b>	Bottom Up		\$88
	Top Down-Bottom Up		\$176
DESIGNER UPGRADE OPTIONS (Add to any Lift System Upgrade Above - Not available on Cord Lock)			ADD
Metallic Hardware (Not available on Lift & Lock or Cord Lock) or Fabric Wrapped Hardware (Not available on Cord Lock)			\$24
MOTORIZATION*			MORE INFO
PowerTouch Rechargeable			Pg 65   \$132
Simplicity - Motor and Battery Wand			Pg 55   \$368
Simplicity Rechargeable Motorization - Motor with Integrated Battery			Pg 57   \$368
Plug-In Charger for Li-Ion Battery Pack (used for PowerTouch and Simplicity Rechargeable and is required)			Pg 59   \$30
Simplicity 5 Channel Remote			Pg 59   \$44
Simplicity 6 Channel Remote with Timer			Pg 59   \$72
Simplicity 14 Channel White Remote			Pg 61   \$72
Simplicity Smart Controller (NEO)			Pg 64   \$363
Top Down-Bottom Up Motorization and Solar Charge Option Pricing			Pg 10
<b>EZ Charge Extension Wand</b>	Wall Mount Receiver Kit 7.4V	\$22	For More Information Page 62
	Extendable Wand 7.4V	\$40	
<b>Low Voltage Hardwiring</b>	9 Channel Wall Mount Hardwired Transformer 12V	\$285	For More Information Page 63
ADDITIONAL OPTIONS		MORE INFO	
Two-On-One/Three-On-One Head Rail		\$52 (Two-On-One)   \$105(Three-On-One) Add to Cord Lock Shade and add lift system upgrade for cord loop or cordless	
For additional options and surcharges refer to page 10.		Pg 10	

\*Motorized Pricing Examples pages 10, 51, 55 and 58

Cellular Shade Collection  
PRICING

Prelude 3/4" Blackout

PRICE GROUP 12  
Cord Lock  
Cordless Lift & Lock

STANDARD RECTANGULAR

		Width In Inches												
		24	30	36	42	48	54	60	66	72	84	96	108	120
Length In Inches	36	171	189	218	243	268	292	316	338	364	416	469	520	576
	42	183	208	233	264	292	318	347	373	401	461	518	577	640
	48	192	223	256	284	316	346	376	408	438	512	585	658	732
	54	207	237	270	304	339	372	414	453	495	577	658	742	823
	60	219	254	292	327	362	414	458	503	549	640	731	823	914
	66	230	268	310	353	403	453	503	554	604	705	805	905	1006
	72	243	280	327	385	439	495	549	604	658	769	878	987	1097
	78	256	299	357	416	476	535	596	655	713	832	951	1070	1188
	84	262	320	385	450	512	577	640	705	769	896	1024	1152	1279
	90	275	343	414	481	549	619	686	754	823	960	1097	1233	1371
	96	293	366	439	512	585	658	731	805	878	1024	1170	1315	1461
	108	330	414	495	577	658	742	823	905	987	1152	1315	1480	1643
120	366	458	549	640	731	823	914	1005	1097	1279	1460	1643	1826	

■ Cord Loop Hardware is recommended on sizes within the shaded area.

Motorized lift systems are not offered within the shaded area.

LIFT SYSTEM AND DESIGN UPGRADES			ADD
Cord Lock	Top Down-Bottom Up		\$68
Cordless Lift & Lock	Bottom Up		No Charge
	Top Down-Bottom Up		\$88
Cordless Ultra	Bottom Up		\$88
	Top Down-Bottom Up		\$176
Cord Loop	Bottom Up		\$88
	Top Down-Bottom Up		\$176
DESIGNER UPGRADE OPTIONS (Add to any Lift System Upgrade Above)			ADD
Metallic Hardware or Fabric Wrapped Hardware			\$24
Scotchgard Stain Protection			\$38
MOTORIZATION*			MORE INFO
PowerTouch Rechargeable			Pg 65 \$132
Simplicity - Motor and Battery Wand			Pg 55 \$368
Simplicity Rechargeable Motorization - Motor with Integrated Battery			Pg 57 \$368
Plug-In Charger for Li-Ion Battery Pack (used for PowerTouch and Simplicity Rechargeable and is required)			Pg 59 \$30
Simplicity 5 Channel Remote			Pg 59 \$44
Simplicity 6 Channel Remote with Timer			Pg 59 \$72
Simplicity 14 Channel White Remote			Pg 61 \$72
Simplicity Smart Controller (NEO)			Pg 64 \$363
Top Down-Bottom Up Motorization and Solar Charge Option Pricing			Pg 10
EZ Charge Extension Wand	Wall Mount Receiver Kit 7.4V	\$22	For More Information Page 62
	Extendable Wand 7.4V	\$40	
Low Voltage Hardwiring	9 Channel Wall Mount Hardwired Transformer 12V	\$285	For More Information Page 63
ADDITIONAL OPTIONS			MORE INFO
For additional options and surcharges refer to page 10.			Pg 10

\*Motorized Pricing Examples pages 10, 51, 55 and 58

**Cellular Shade Collection**  
**PRICING**

This fabric is best for Room Darkening SlumberShades.

**SlumberShade Fabric**  
**Premiere 3/4" Blackout**

**PRICE GROUP 13**  
**SlumberShade Fabric**

Price grid is for shades only. SlumberShade Tracks are a separate charge - See below.

Width In Inches

	24	30	36	42	48	54	60	66	72	84	96	108	120	132	144
36	220	246	281	314	346	377	409	437	470	540	608	673	747	812	879
42	236	271	303	341	377	413	450	483	519	596	670	748	829	912	996
48	249	290	329	368	409	449	485	528	567	665	758	853	949	1043	1138
54	267	307	351	393	439	481	535	587	640	748	853	959	1065	1172	1280
60	284	328	377	423	468	535	593	652	712	829	948	1065	1185	1302	1421
66	297	346	401	457	523	587	652	718	782	912	1043	1172	1302	1430	1563
72	314	363	423	498	570	640	712	782	853	996	1138	1280	1421	1563	1705
78	329	387	463	540	618	693	770	848	923	1078	1233	1384	1538	1693	1845
84	340	415	498	582	665	748	829	912	996	1159	1326	1492	1657	1822	1987
90	355	446	535	623	712	800	890	977	1065	1242	1421	1597	1774	1952	2129
96	381	476	570	665	758	853	948	1043	1138	1326	1515	1705	1893	2082	2270
108	428	535	640	748	853	959	1065	1172	1280	1492	1705	1915	2129	2340	2555
120	476	593	712	829	948	1065	1185	1300	1421	1657	1892	2129	2365	2602	2838

 Cord Loop Hardware is recommended on sizes within the shaded area.  
Motorized Lift Systems are not offered within the shaded area.

Widths over 108" will be built as Two-On-One Shades.

STANDARD RECTANGULAR

LIFT SYSTEM AND DESIGN UPGRADES			ADD
Cord Lock	Top Down-Bottom Up		\$68
Cordless Lift & Lock	Bottom Up		No Charge
	Top Down-Bottom Up		\$88
Cordless Ultra	Bottom Up		\$88
	Top Down-Bottom Up		\$176
Cord Loop	Bottom Up		\$88
	Top Down-Bottom Up		\$176
DESIGNER UPGRADE OPTIONS (Add to any Lift System Upgrade Above)			ADD
Metallic Hardware or Fabric Wrapped Hardware			\$24
Scotchgard Stain Protection			\$38
MOTORIZATION*			MORE INFO
PowerTouch Rechargeable			Pg 65 \$132
Simplicity - Motor and Battery Wand			Pg 55 \$368
Simplicity Rechargeable Motorization - Motor with Integrated Battery			Pg 57 \$368
Plug-In Charger for Li-Ion Battery Pack (used for PowerTouch and Simplicity Rechargeable and is required)			Pg 59 \$30
Simplicity 5 Channel Remote			Pg 59 \$44
Simplicity 6 Channel Remote with Timer			Pg 59 \$72
Simplicity 14 Channel White Remote			Pg 61 \$72
Simplicity Smart Controller (NEO)			Pg 64 \$363
Top Down-Bottom Up Motorization and Solar Charge Option Pricing			Pg 10
EZ Charge Extension Wand	Wall Mount Receiver Kit 7.4V	\$22	For More Information Page 62
	Extendable Wand 7.4V	\$40	
Low Voltage Hardwiring	9 Channel Wall Mount Hardwired Transformer 12V	\$285	For More Information Page 63
ADDITIONAL OPTIONS			ADD
Slumbershade Light Blocking Sidetrack System   See page 69 for more information.			\$142

\*Motorized Pricing Examples pages 10, 51, 55 and 58

# Ovation Cellular Slider Shade SIZE STANDARDS



OVATION CELLULAR SLIDERS

Ovation Cellular Slider	
Standard	
ALL FABRICS	Minimum Width 12"
	Minimum Length 24"

Light Filtering	Price Group	Page	Ovation Cellular Slider	
Debut 1/2" Single Debut 1/2" Double Aspen 3/4" Symphony 3/8"	14	25	Maximum Width & Length	120"* x 108"
Verona 3/4" Boutique 3/4" Debut 3/4" Linen Weave 3/4" Premiere 3/4"	14	25	Maximum Width & Length	168*** x 108"
Prelude 3/4"	15	25	Maximum Width & Length	168*** x 120"

Room Darkening & Blackout	Price Group	Page	Ovation Cellular Slider	
Verona 3/4" Boutique 3/4" Linen Weave 3/4" Premiere 3/4"	16	26	Maximum Width & Length	168*** x 108"
Prelude 3/4"	17	26	Maximum Width & Length	168*** x 120"

Maximum Square Footage Side=100"  
Split=140"

Ovation Cellular Slider	
More Information On Page	Page 67

- \* Split stack sliders are available in widths up to 240"; however, if the width exceeds 120", it will be fabricated as two separate sliders. The supplied valance will create the appearance of a single slider.
- \*\* Split stack sliders are available to 336", however if the width exceeds 168", the shade will be fabricated as two separate sliders. Supplied valance will create the appearance of a single slider. Please call customer service for assistance.
- \*\*\* Prelude split stack can go up to 190" wide on one head rail.

Ovation Cellular Slider Shade  
PRICING

**LIGHT FILTERING FABRICS**

Boutique 3/4"

Debut 1/2

Debut 1/2" Double Cell

Debut 3/4"

Linen Weave 3/4"

Premiere 3/4"

Aspen 3/8" Double Cell

Symphony 3/8"

Verona 3/4"

Virtuoso 1/2"

**PRICE GROUP 14**  
**Ovation Cellular Slider**

		Width In Inches																	
		24	30	36	42	48	54	60	66	72	78	84	96	108	120	132	144	156	168
Length In Inches	36	505	547	596	640	677	723	769	809	854	902	941	1019	1096	1179	1259	1341	1425	1507
	42	537	589	641	693	735	785	839	884	938	986	1029	1120	1205	1304	1400	1495	1591	1688
	48	572	624	689	743	794	846	905	962	1017	1065	1121	1227	1319	1426	1532	1638	1742	1848
	54	603	668	732	795	847	908	966	1034	1096	1153	1214	1327	1434	1549	1667	1782	1902	2017
	60	638	706	775	843	905	971	1038	1108	1173	1238	1302	1427	1546	1672	1802	1929	2057	2188
	66	674	747	822	895	962	1033	1102	1185	1252	1327	1386	1532	1658	1797	1930	2067	2203	2340
	72	711	787	867	949	1025	1097	1172	1258	1334	1412	1480	1639	1770	1923	2076	2231	2384	2536
	78	747	831	916	1003	1083	1162	1241	1336	1414	1496	1569	1736	1881	2044	2206	2368	2533	2694
	84	785	872	961	1059	1143	1227	1312	1410	1496	1583	1661	1840	1995	2165	2340	2512	2682	2854
	90	819	912	1012	1113	1198	1291	1384	1488	1579	1669	1757	1944	2105	2295	2485	2675	2866	3056
96	853	953	1060	1164	1257	1351	1458	1564	1661	1759	1847	2049	2221	2416	2611	2807	3005	3199	
108	886	990	1105	1219	1313	1414	1527	1636	1741	1847	1939	2154	2335	2537	2737	2939	3139	3339	
114	932	1040	1162	1279	1380	1485	1613	1723	1834	1947	2043	2271	2463	2670	2867	3067	3266	3467	
120	978	1092	1223	1341	1447	1557	1693	1808	1927	2048	2147	2387	2590	2802	3010	3216	3423	3630	

**Prelude 3/4" Light Filtering**

**PRICE GROUP 15**  
**Ovation Cellular Slider**

		Width In Inches																	
		24	30	36	42	48	54	60	66	72	78	84	96	108	120	132	144	156	168
Length In Inches	36	376	406	442	476	504	538	572	602	635	671	700	757	815	876	936	998	1060	1121
	42	399	438	477	515	547	584	623	657	697	733	765	833	896	970	1041	1112	1183	1255
	48	425	464	513	552	590	630	673	715	756	792	834	912	981	1061	1139	1218	1296	1375
	54	449	496	544	591	630	675	719	769	815	857	902	987	1066	1152	1240	1325	1414	1500
	60	475	524	576	627	673	721	772	824	873	920	968	1062	1150	1243	1341	1434	1530	1628
	66	501	556	612	666	715	768	819	882	931	987	1031	1139	1233	1336	1435	1538	1638	1740
	72	529	585	645	705	762	816	872	936	991	1050	1100	1219	1316	1431	1544	1659	1773	1886
	78	556	618	681	746	805	864	923	993	1052	1113	1167	1291	1399	1521	1640	1761	1883	2004
	84	584	648	714	787	850	912	975	1048	1113	1178	1235	1368	1484	1611	1740	1868	1995	2123
	90	609	678	753	828	891	960	1029	1107	1174	1242	1306	1446	1566	1707	1848	1989	2132	2273
96	634	709	788	865	935	1005	1084	1162	1235	1308	1374	1523	1652	1797	1942	2088	2234	2379	
102	658	737	821	907	976	1052	1135	1216	1295	1374	1441	1602	1737	1887	2035	2186	2334	2484	
108	693	774	864	951	1026	1105	1199	1281	1364	1449	1520	1689	1832	1986	2133	2281	2430	2578	
114	728	811	909	998	1076	1158	1260	1344	1432	1522	1596	1775	1926	2084	2239	2392	2546	2700	
120	761	849	951	1045	1127	1211	1323	1407	1502	1597	1672	1862	2021	2182	2342	2503	2661	2825	

<b>PRODUCT INFORMATION</b>	
See Page 67 for detailed information.	
<b>DESIGN UPGRADES</b>	
Left or Right Stack	Included, specify when ordering
Center Stack	Add \$88
Split Stack*	Price by dividing the full width measurement in half. Price as two separate units and add together.
Dual Panel**	Price as two separate units and add together.
<b>FABRIC SURCHARGES</b>	
Prints and Duotones	<b>ADD</b> Add 20%
Flame Resistant 3/8" Double Cell	Add 30%
Flame Resistant 3/4" Single Cell	Add 30%

\* Split stack sliders are available in widths up to 240". If the width exceeds 120", it will be fabricated as two separate sliders. The supplied valance will create the appearance of a single slider.

\*\* A Dual Panel Stack Slider has a center opening design with a different fabric on each side, each of which can span the full width of the window. Both panels will be of equal width unless otherwise specified.

Ovation Cellular Slider Shade

PRICING

ROOM DARKENING & BLACKOUT FABRICS

Boutique 3/4"  
Linen Weave 3/4"

Premiere 3/4"  
Verona 3/4"

PRICE GROUP 16  
Ovation Cellular Slider

		Width In Inches																	
		24	30	36	42	48	54	60	66	72	78	84	96	108	120	132	144	156	168
Length In Inches	36	657	712	775	832	881	940	1000	1052	1111	1173	1224	1325	1425	1533	1637	1744	1853	1960
	42	699	766	834	901	956	1021	1091	1150	1220	1282	1338	1456	1567	1696	1820	1944	2069	2195
	48	744	812	896	966	1033	1100	1177	1251	1323	1385	1458	1596	1715	1854	1992	2130	2265	2403
	54	784	869	952	1034	1102	1181	1256	1345	1425	1499	1579	1726	1865	2014	2168	2317	2473	2623
	60	830	918	1008	1096	1177	1263	1350	1441	1525	1610	1693	1856	2010	2174	2343	2508	2675	2845
	66	877	972	1069	1164	1251	1343	1433	1541	1628	1726	1802	1992	2156	2337	2509	2688	2864	3042
	72	925	1024	1128	1234	1333	1427	1524	1636	1735	1836	1924	2131	2301	2500	2699	2901	3100	3297
	78	972	1081	1191	1304	1408	1511	1614	1737	1839	1945	2040	2257	2446	2658	2868	3079	3293	3503
	84	1021	1134	1250	1377	1486	1596	1706	1833	1945	2058	2160	2392	2594	2815	3042	3266	3487	3711
	90	1065	1186	1316	1447	1558	1679	1800	1935	2053	2170	2285	2528	2737	2984	3231	3478	3726	3973
	96	1109	1239	1378	1514	1635	1757	1896	2034	2160	2287	2402	2664	2888	3141	3395	3650	3907	4159
	108	1152	1287	1437	1585	1707	1839	1986	2127	2264	2402	2521	2801	3036	3299	3559	3821	4081	4341
114	1212	1352	1511	1663	1794	1931	2097	2240	2385	2532	2656	2953	3202	3471	3728	3988	4246	4508	
120	1272	1420	1590	1744	1882	2025	2201	2351	2506	2663	2792	3104	3367	3643	3913	4181	4450	4719	

Prelude 3/4" Blackout

PRICE GROUP 17  
Ovation Cellular Slider

		Width In Inches																	
		24	30	36	42	48	54	60	66	72	78	84	96	108	120	132	144	156	168
Length In Inches	36	508	549	597	643	681	727	773	813	858	906	945	1022	1101	1183	1264	1348	1431	1514
	42	539	592	644	696	739	789	842	887	941	990	1033	1125	1210	1310	1406	1502	1598	1695
	48	574	627	693	746	797	851	909	966	1021	1070	1126	1232	1325	1433	1538	1645	1750	1857
	54	607	670	735	798	851	912	971	1039	1101	1157	1218	1333	1440	1556	1674	1789	1909	2025
	60	642	708	778	847	909	974	1043	1113	1179	1242	1307	1434	1553	1679	1811	1936	2066	2198
	66	677	751	827	900	966	1037	1106	1191	1257	1333	1392	1538	1665	1804	1938	2077	2212	2349
	72	715	790	871	952	1029	1102	1178	1264	1338	1418	1485	1646	1777	1932	2085	2240	2394	2547
	78	751	835	920	1008	1087	1167	1247	1341	1421	1503	1576	1743	1889	2054	2214	2378	2543	2706
	84	789	875	964	1063	1148	1232	1317	1415	1503	1591	1668	1847	2004	2175	2349	2522	2694	2867
	90	823	916	1017	1118	1203	1296	1390	1495	1585	1677	1764	1953	2115	2305	2495	2686	2879	3069
	96	856	958	1064	1168	1263	1357	1464	1569	1668	1766	1855	2057	2231	2426	2622	2819	3016	3212
	102	889	995	1109	1225	1318	1421	1533	1642	1749	1855	1946	2163	2345	2548	2748	2952	3151	3354
108	936	1045	1167	1284	1386	1492	1619	1730	1842	1957	2052	2281	2474	2682	2880	3080	3281	3481	
114	983	1095	1228	1348	1453	1564	1701	1815	1934	2055	2155	2397	2601	2814	3023	3230	3438	3645	
120	1028	1147	1284	1411	1522	1635	1787	1900	2028	2156	2258	2514	2729	2946	3162	3380	3593	3814	

PRODUCT INFORMATION

See Page 98 for detailed information.

DESIGN UPGRADES

Left or Right Stack	Included, specify when ordering
Center Stack	Add \$88
Split Stack*	Price by dividing the full width measurement in half. Price as two separate units and add together.
Dual Panel**	Price as two separate units and add together.

FABRIC SURCHARGES

	ADD
Prints and Duotones	Add 20%
Flame Resistant 3/8" Double Cell	Add 30%
Flame Resistant 3/4" Single Cell	Add 30%

\* Split stack sliders are available in widths up to 240". If the width exceeds 120", it will be fabricated as two separate sliders. The supplied valance will create the appearance of a single slider.

\*\* A Dual Panel Stack Slider has a center opening design with a different fabric on each side, each of which can span the full width of the window. Both panels will be of equal width unless otherwise specified.

OVATION CELLULAR SLIDERS

# Speciality Shaped Shades SIZE STANDARDS

SPECIALITY SHAPED SHADES

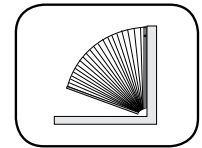
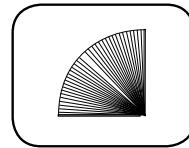
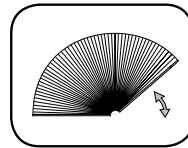
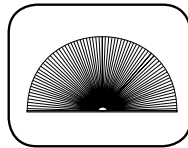

		Starburst Non-Movable Arch	Starburst Movable Arch	Quarter Round Non-Movable	Quarter Round Movable
ALL FABRICS (except 3/4" Prelude)	Minimum Width	18"	18"	9"	9"
	Minimum Length	9"	9"	9"	9"
Prelude 3/4"	Minimum Width	12"	12"	12"	12"
	Minimum Length	12"	12"	12"	12"

Light Filtering	Price Group	Page		Starburst Non-Movable Arch	Starburst Movable Arch	Quarter Round Non-Movable	Quarter Round Movable
Verona 3/4"	18	29	Maximum Width & Length	72" x 36"	72" x 36"	48" x 48"	48" x 48"
Boutique 3/4"				72" x 36"	72" x 36"	48" x 48"	48" x 46"
Debut 1/2" Double				60" x 48"	72" x 36"	48" x 48"	48" x 48"
Debut 1/2" Single				60" x 48"	72" x 36"	52" x 52"	48" x 48"
Debut 3/4"				60" x 48"	72" x 36"	48" x 48"	48" x 48"
Linen Weave 3/4"				72" x 36"	72" x 36"	48" x 48"	48" x 48"
Premiere 1/2"				60" x 48"	72" x 36"	48" x 48"	48" x 48"
Premiere 3/4"				72" x 36"	72" x 36"	48" x 48"	48" x 48"
Aspen 3/8"				72" x 36"	72" x 36"	48" x 48"	48" x 48"
Symphony 3/8"				96" x 48"	72" x 36"	52" x 52"	48" x 48"
Prelude 3/4"	19	29	Max Width & Length	84" x 42"	84" x 42"	42" x 42"	42" x 42"

Room Darkening & Blackout	Price Group	Page #		Starburst Non-Movable Arch	Starburst Movable Arch	Quarter Round Non-Movable	Quarter Round Movable
Verona 3/4"	20	30	Maximum Width & Length	72" x 36"	72" x 36"	48" x 48"	48" x 48"
Boutique 3/4"				72" x 36"	72" x 36"	48" x 48"	48" x 48"
Linen Weave 3/4"				72" x 36"	72" x 36"	48" x 48"	48" x 48"
Premiere 1/2"				60" x 48"	72" x 36"	48" x 48"	48" x 48"
Premiere 3/4"				72" x 36"	72" x 36"	48" x 48"	48" x 48"
Symphony 3/8"				96" x 48"	72" x 36"	52" x 52"	48" x 48"
Prelude 3/4"	21	30	Max Width & Length	84" x 42"	84" x 42"	42" x 42"	42" x 42"

	Starburst Non-Movable Arch	Starburst Movable Arch	Quarter Round Non-Movable	Quarter Round Movable
More Information On Page	Page 71	Page 71	Page 74	Page 74

\* Starburst Movable Arches are available as inside mount only.  
 \*\* Through our maximum width is 84" and our maximum is 72" on Sunset Arches, there are limitations on some larger sizes due to excessive weight. If the Sunset width exceeds 66", the maximum length is 60". If the Sunset width exceeds 72", the maximum length is 48".



Speciality Shaped Shades  
**SIZE STANDARDS**

SPECIALTY SHAPED SHADES

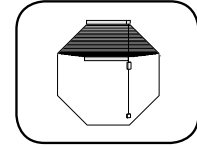
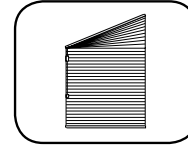
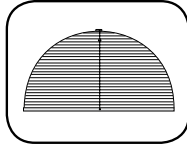

		Sunset Arch	Trapezoid	Octagon
ALL FABRICS (except 3/4" Prelude)	Minimum Width	18"	12"	12"
	Minimum Length	6"	12"	12"
Prelude 3/4"	Minimum Width	18"	12"	8"
	Minimum Length	6"	12"	8"

Light Filtering	Price Group	Page		Sunset Arch	Price Group	Page	Trapezoid	Octagon
Verona 3/4"	22	31	Maximum Width & Length	72" x 60"	26	33	48" x 72"	48" x 48"
Boutique 3/4"				72" x 60"			48" x 72"	48" x 48"
Debut 1/2" Double				84" x 72"***			60" x 72"	48" x 48"
Debut 1/2" Single				84" x 72"***			60" x 72"	48" x 48"
Debut 3/4"				84" x 72"***			60" x 72"	48" x 48"
Linen Weave 3/4"				72" x 60"			48" x 72"	48" x 48"
Premiere 1/2"				84" x 72"***			60" x 72"	48" x 48"
Premiere 3/4"				84" x 72"***			48" x 72"	48" x 48"
Aspen 3/8"				84" x 72"			48" x 72"	48" x 48"
Symphony 3/8"				84" x 72"***			60" x 72"	48" x 48"
Prelude 3/4"	23	31	Max Width & Length	84" x 48"	27	33	48" x 84"	30" x 30"

Room Darkening & Blackout	Price Group	Page		Sunset Arch	Price Group	Page	Trapezoid	Octagon
Verona 3/4"	24	32	Maximum Width & Length	60" x 60"	28	34	48" x 72"	48" x 48"
Boutique 3/4"				60" x 60"			48" x 72"	48" x 48"
Linen Weave 3/4"				60" x 60"			48" x 72"	48" x 48"
Premiere 1/2"				60" x 60"			48" x 72"	48" x 48"
Premiere 3/4"				60" x 60"			48" x 72"	48" x 48"
Symphony 3/8"				NA			60" x 72"	48" x 48"
Prelude 3/4"	25	32	Max Width & Length	84" x 48"	29	34	48" x 72"	30" x 30"

	Sunset Arch	Trapezoid	Octagon
More Information On Page	Page 72	Page 74	Page 74

\*Starburst Movable Arches are available as inside mount only.

\*\*Through our maximum width is 84" and our maximum is 72" on Sunset Arches, there are limitations on some larger sizes due to excessive weight. If the Sunset width exceeds 66", the maximum length is 60". If the Sunset width exceeds 72", the maximum length is 48".

# Speciality Shaped Shades

## PRICING

### LIGHT FILTERING FABRICS

- Boutique 3/4"
- Debut 1/2" Single Cell
- Debut 1/2" Double Cell
- Debut 3/4" Single Cell
- Linen Weave 3/4"
- Premiere 1/2"
- Premiere 3/4"
- Aspen 3/8" Double Cell
- Symphony 3/8" Double Cell
- Verona 3/4"

### PRICE GROUP 18

Starburst Arches  
Quarter Rounds

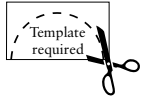

For widths wider than 58"

	Width In Inches												
	24	30	36	42	48	54	60	66	72	78	84	90	96
Non-Movable Starburst	272	309	351	400	479	549	619	699	787	880	978	1084	1205
Movable Starburst	384	435	496	560	670	751	845	945	1055				
Non-Movable Quarter Rounds	351	400	456	520	591	672							
Movable Quarter Rounds	479	543	617	696	787								

**Product Information:** All fabrics are not available in all widths, lengths and hardware options. Refer to Size Specifications on page 27 and 28 for availability. See pages 71 and 74-75 for detailed information. Templates required on non-perfect non-movable Starburst Arches and Quarter Rounds. Movable Starburst Arch shades are for inside and shallow mount applications only.

### Prelude 3/4" Light Filtering

### PRICE GROUP 19

Starburst Arches  
Quarter Rounds

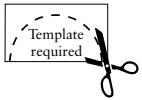

For widths wider than 58"

	Width In Inches										
	24	30	36	42	48	54	60	66	72	78	84
Stationary Starburst	245	279	316	360	432	495	558	630	709	792	881
Movable Starburst	346	392	447	504	603	676	761	851	950	1045	1150
Stationary Quarter Round	319	363	411	468							
Movable Quarter Round	NOT AVAILABLE										

FABRIC SURCHARGES		ADD
Scotchgard Stain Protector		\$38
Debut 1/2" Single Cell Print Fabric	Includes: Homespun, Country Woven, Florance, Strata, Angel Hair, Blossom, Terrazzo and Strie	20%
Debut 1/2" Double Cell Print Fabric Debut 3/4" Single Cell Print Fabric	Includes: Homespun, Country Woven, Florance, Strata and Angel Hair	20%
Premiere Fabric	Includes: Homespun, Country Woven, Florance, Spheres, Strata, Tuscan Scroll, Angel Hair, Blossom, and Gradients	20%
Symphony Fabric	Symphony Prints and Duotones	20%
	Symphony Double Cell Flame Resistant	30%
PRICING INFORMATION		
Starburst Arches	Price according to the largest radius measurement. If the height is greater than the width, take height X 2 and use that number to determine pricing. Metallic rails available.	
Quarter Rounds	Price according to the largest radius measurement.	
HARDWARE UPGRADE SURCHARGES* AND ACCESSORIES		ADD
6 Foot Expandable Pole		\$44
12 Foot Expandable Pole		\$54

Speciality Shaped Shades

PRICING

SPECIALITY SHAPED SHADES

**ROOM DARKENING & BLACKOUT FABRICS**

**PRICE GROUP 20**

Boutique 3/4"  
Linen Weave 3/4"  
Premiere 1/2"

Premiere 3/4"  
Symphony 3/8" Double Cell  
Verona 3/4"

Starburst Arches  
Quarter Round

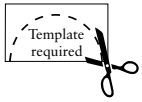

For widths wider than 58"

Width In Inches

	24	30	36	42	48	54	60	66	72	78	84	90	96
Non-Movable Starburst	354	402	457	520	623	714	805	909	1024	1144	1272	1410	1567
Movable Starburst	500	566	645	728	871	977	1099	1229	1372				
Non-Movable Quarter Rounds	457	520	593	676	769	874							
Movable Quarter Rounds	623	706	803	905	1024								

**Product Information:** All fabrics are not available in all widths, lengths and hardware options. Refer to Size Specifications on page 27 and 28 for availability. See pages 71 and 74-75 for detailed information. Templates required on non-perfect non-movable Starburst Arches and Quarter Rounds. Movable Starburst Arch shades are for inside and shallow mount applications only.

**Prelude 3/4" Blackout**

**PRICE GROUP 21**

Starburst Arches  
Quarter Rounds

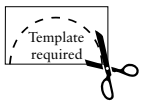

For widths wider than 58"

Width In Inches

	24	30	36	42	48	54	60	66	72	78	84
Stationary Starburst	331	377	427	486	584	669	754	851	958	1070	1190
Movable Starburst	468	530	604	681	815	913	1028	1149	1283	1411	1553
Stationary Quarter Round	431	491	555	632							
Movable Quarter Round											

**Product Information:** See pages 107 and 110 for detailed information. Templates required on non-perfect non-movable Starburst Arches and Quarter Rounds. Movable Starburst Arch shades are for inside and shallow mount applications only.

FABRIC SURCHARGES		ADD
Scotchgard Stain Protector		\$38
Premiere Fabric	Includes: Homespun, Country Woven, Florance, Spheres, Strata, Tuscan Scroll, Angel Hair, Blossom, and Gradients	20%
PRICING INFORMATION		
Starburst Arches	Price according to the largest radius measurement. If the height is greater than the width, take height X 2 and use that number to determine pricing. Metallic rails available.	
Quarter Rounds	Price according to the largest radius measurement.	
HARDWARE UPGRADE SURCHARGES* AND ACCESSORIES		ADD
6 Foot Expandable Pole		\$44
12 Foot Expandable Pole		\$54

**Please note:** On the Stationary Starburst Arches when the fabric wrapped hardware is selected, the fabric wrap will be spliced in the center of the base rail.

# Speciality Shaped Shades PRICING

## LIGHT FILTERING

Boutique 3/4"  
Debut 1/2" Single Cell  
Debut 1/2" Double Cell  
Debut 3/4" Single Cell  
Linen Weave 3/4"

Premiere 1/2"  
Premiere 3/4"  
Aspen 3/8" Double Cell  
Symphony 3/8" Double Cell  
Verona 3/4"

## PRICE GROUP 22 Sunset Movable Arches

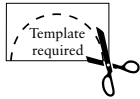

For widths wider than 58"

		Width In Inches										
		24	30	36	42	48	54	60	66	72	78	84
Length In Inches	<b>Half Round</b>	352	392	416	467	498	559	594	653	714	771	850
	<b>36</b>	456	499	524	560	585	628	647	682	714	746	774
	<b>42</b>	481	531	553	608	629	678	700	739	774	814	850
	<b>48</b>	510	560	591	645	669	709	753	793	836	878	925
	<b>60</b>	558	628	659	728	760	825	860	910	960	1014	1063
	<b>72</b>	613	689	730	810	850	927	972	1027	1091	1144	1206

**Product Information:** All fabrics are not available in all widths, lengths and hardware options. Refer to Size Specifications on page 28 for availability. See pages 72-73 for detailed information. Templates required on non-perfect Sunset Arches.

## Prelude 3/4" Light Filtering

## PRICE GROUP 23 Sunset Movable Arches

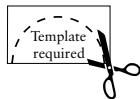

For widths wider than 58"

		Width In Inches										
		24	30	36	42	48	54	60	66	72	78	84
Length In Inches	<b>Half Round</b>	317	353	375	421	449	504	535	588	643	694	765
	<b>36</b>	411	450	472	504	527	566	583	614	643	672	697
	<b>42</b>	433	478	498	548	567	611	630	666	697	733	765
	<b>48</b>	459	504	532	581	603	639	678	714	753	791	833

FABRIC SURCHARGES		ADD
Scotchgard Stain Protector		\$38
Debut 1/2" Single Cell Print Fabric	Includes: Homespun, Country Woven, Florance, Strata, Angel Hair, Blossom, Terrazzo and Strie	20%
Debut 1/2" Double Cell Print Fabric Debut 3/4" Single Cell Print Fabric	Includes: Homespun, Country Woven, Florance, Strata and Angel Hair	20%
Premiere Fabric	Includes: Homespun, Country Woven, Florance, Spheres, Strata, Tuscan Scroll, Angel Hair, Blossom, and Gradients	20%
Symphony Fabric	Symphony Prints and Duotones	20%
	Symphony Double Cell Flame Resistant	30%
HARDWARE UPGRADE SURCHARGES AND ACCESSORIES		ADD
6 Foot Expandable Pole		\$44
12 Foot Expandable Pole		\$54

Speciality Shaped Shades

PRICING

SPECIALTY SHAPED SHADES

**ROOM DARKENING & BLACKOUT FABRICS**

Boutique 3/4"  
Linen Weave 3/4"  
Premiere 1/2"

Premiere 3/4"  
Verona 3/4"

**PRICE GROUP 24**  
**Sunset Movable Arches**



For widths wider than 58"

		Width In Inches						
		24	30	36	42	48	54	60
Length In Inches	Half Round	458	510	541	608	648	727	773
	36	593	649	682	728	761	817	842
	42	626	691	719	791	818	882	910
	48	663	728	769	839	870	922	979
	60	726	817	857	947	988	1073	1118

**Product Information:** All fabrics are not available in all widths, lengths and hardware options. Refer to Size Specifications on page 28 for availability. See pages 72-73 for detailed information. Templates required on non-perfect Sunset Arches.

**Prelude 3/4" Blackout**

**PRICE GROUP 25**  
**Sunset Movable Arches**



For widths wider than 58"

		Width In Inches										
		24	30	36	42	48	54	60	66	72	78	84
Length In Inches	Half Round	428	477	507	569	607	681	723	794	869	937	1033
	36	555	608	638	681	712	765	788	829	869	908	941
	42	585	646	673	740	766	825	851	900	941	990	1033
	48	620	681	719	785	815	863	916	964	1017	1068	1125

**Product Information:** See pages 108-109 for detailed information. Templates required on non-perfect Sunset Arches.

FABRIC SURCHARGES		ADD
Scotchgard Stain Protector		\$38
Premiere Fabric	Includes: Homespun, Country Woven, Florance, Spheres, Strata, Tuscan Scroll, Angel Hair, Blossom, and Gradients	20%
HARDWARE UPGRADE SURCHARGES AND ACCESSORIES		ADD
6 Foot Expandable Pole		\$44
12 Foot Expandable Pole		\$54

# Speciality Shaped Shades PRICING

## LIGHT FILTERING

Boutique 3/4"  
Debut 1/2" Single Cell  
Debut 1/2" Double Cell  
Debut 3/4" Single Cell  
Linen Weave 3/4"

Premiere 1/2"  
Premiere 3/4"  
Aspen 3/8" Double Cell  
Symphony 3/8" Double Cell  
Verona 3/4"

## PRICE GROUP 26 Trapezoids and Octagons

		Width In Inches						
		24	30	36	42	48	54	60
Length In Inches	36	486	515	551	590	624	657	689
	42	504	538	577	619	657	694	734
	48	519	559	605	649	689	731	776
	54	537	579	629	676	722	770	815
	60	555	602	656	705	754	811	860
	66	573	624	682	735	791	847	898
	72	590	643	705	766	825	884	945

All fabrics are not available in all widths, lengths and applications. Refer to Size Specifications on page 28 for availability.  
**Product Information:** See pages 76-78 for detailed information. Width, length and one side are required measurements for Octagon Shades. Trapezoid orders must be emailed in with a diagram that includes the measurements for 4 sides. No templates are required for Trapezoid Shades. \* Virtuoso fabrics are available as Octagons only.

## Prelude 3/4" Light Filtering

## PRICE GROUP 27 Trapezoids and Octagons

		Width In Inches						
		24	30	36	42	48	54	60
Length In Inches	36	438	464	496	531	562	592	621
	42	454	485	520	558	592	625	661
	48	468	504	545	585	621	658	699
	54	484	522	567	609	650	693	734
	60	500	542	591	635	679	730	774
	66	516	562	614	662	712	763	809
	72	531	579	635	690	743	796	851

**Product Information:** See page 111-112 for detailed information. Templates required on all Octagon orders.

FABRIC SURCHARGES		ADD
Scotchgard Stain Protector		\$38
Debut 1/2" Single Cell Print Fabric	Includes: Homespun, Country Woven, Florance, Strata, Angel Hair, Blossom, Terrazzo and Strie	20%
Debut 1/2" Double Cell Print Fabric Debut 3/4" Single Cell Print Fabric	Includes: Homespun, Country Woven, Florance, Strata and Angel Hair	20%
Premiere Fabric	Includes: Homespun, Country Woven, Florance, Spheres, Strata, Tuscan Scroll, Angel Hair, Blossom, and Gradients	20%
Symphony Fabric	Symphony Prints and Duotones	20%
	Symphony Double Cell Flame Resistant	30%
HARDWARE UPGRADE SURCHARGES AND ACCESSORIES		ADD
6 Foot Expandable Pole		\$44
12 Foot Expandable Pole		\$54

Speciality Shaped Shades

PRICING

SPECIALITY SHAPED SHADES

ROOM DARKENING & BLACKOUT FABRICS

Boutique 3/4"  
Linen Weave 3/4"  
Premiere 1/2"

Premiere 3/4"  
Symphony 3/8"  
Verona 3/4"

PRICE GROUP 28  
Trapezoids and Octagons

Length In Inches	Width In Inches						
	24	30	36	42	48	54	60
36	632	670	717	767	812	855	896
42	656	700	751	805	855	903	955
48	675	727	787	844	896	951	1009
54	699	753	818	879	939	1001	1060
60	722	783	853	917	981	1055	1118
66	745	812	887	956	1029	1102	1168
72	767	836	917	996	1073	1150	1229

All fabrics are not available in all widths, lengths and applications. Refer to Size Specifications on page 28 for availability.  
**Product Information:** See page 76-77 for detailed information. Templates required on all Octagon orders. Width, length and one side are required measurements for Octagon Shades. **Trapezoid orders must be faxed in with a diagram that includes the measurements for 4 sides.** No templates are required for Trapezoid Shades.

Prelude 3/4" Blackout

PRICE GROUP 29  
Trapezoids and Octagons

Length In Inches	Width In Inches						
	24	30	36	42	48	54	60
36	592	627	670	717	759	800	839
42	613	655	702	754	800	844	893
48	632	681	736	790	839	889	944
54	654	705	766	823	878	936	991
60	675	732	798	858	917	986	1045
66	697	759	829	894	962	1031	1093
72	717	782	858	932	1004	1075	1149

**Product Information:** See page 111-112 for detailed information. Templates required on all Octagon orders. Width, length and one side are required measurements for Octagon Shades. **Trapezoid orders must be faxed in with a diagram that includes the measurements for 4 sides.** No templates are required for Trapezoid Shades.

FABRIC SURCHARGES		ADD
Scotchgard Stain Protector		\$38
Premiere Fabric	Includes: Homespun, Country Woven, Florance, Spheres, Strata, Tuscan Scroll, Angel Hair, Blossom, and Gradients	20%
HARDWARE UPGRADE SURCHARGES AND ACCESSORIES		ADD
6 Foot Expandable Pole		\$44
12 Foot Expandable Pole		\$54

# Comfortex Skylight and Greenhouse Shades

## SIZE STANDARDS

SPECIALTY SHAPED SHADES

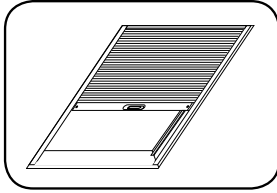

	Minimum	Balcony* 0°-15°   15°-75°   75°-90°***	Soprano*** Skylight/Greenhouse	Mezzo
<b>ALL FABRICS</b> (except ¼" Prelude)	Min Width	15"	11"	18"
	Min Length	12"	11"	12"
Prelude ¼"	Min Width	18"		
	Min Length	12"		

Light Filtering	Price Group Page	Max Width & Length	Balcony			Soprano Skylight/Greenhouse	Price Group Page	Mezzo	Price Group Page
			0°-15°	15°-75°	75°-90°				
Verona ¼"	Grid 31 Page 37	Max Width & Length	NA	NA	NA	48" x 72"	Grid 30 Page 36	48" x 72"	Grid 33 Page 39
Boutique ¼"			NA	NA	NA	48" x 72"		48" x 72"	
Debut ½" Double			NA	NA	NA	NA		48" x 72"	
Debut ½" Single			36" x 96"	48" x 96"	48" x 72"	36" x 144" SL 29" x 180" GH		48" x 72"	
Debut ¾"			NA	NA	NA	NA		48" x 72"	
Linen Weave ¾"			NA	NA	NA	48" x 72"		48" x 72"	
Premiere ½"			NA	NA	NA	NA		48" x 72"	
Premiere ¾"			NA	NA	NA	NA		48" x 72"	
Aspen ⅝"			36" x 96"	48" x 72"	48" x 72"	48" x 72"		48" x 72"	
Symphony ⅝"			36" x 96"	48" x 96"	48" x 72"	48" x 144" SL 36" x 180" GH		48" x 72"	
Prelude ¼"	Grid 35 Pg 41	Max Width & Length	60" x 72" 25 sq ft						

Room Darkening & Blackout	Price Group Page	Max Width & Length	Balcony			Soprano Skylight/Greenhouse	Price Group Page	Mezzo	Price Group Page
			0°-15°	15°-75°	75°-90°				
Verona ¼"	Grid 32 Page 38	Max Width & Length	NA	NA	NA	48" x 72"	NA	48" x 72"	Grid 34 Page 40
Boutique ¼"			NA	NA	NA	48" x 72"		48" x 72"	
Linen Weave ¾"			NA	NA	NA	48" x 72"		48" x 72"	
Premiere ½"			NA	NA	NA	NA		48" x 72"	
Premiere ¾"			NA	NA	NA	NA		48" x 72"	
Symphony ⅝"			36" x 96"	48" x 96"	48" x 72"	NA		48" x 72"	
Prelude ¼"	Grid 36 Pg 41		60" x 72" 25 sq ft						

More Information On Page	Page 80	Page 78	Page 82
--------------------------	---------	---------	---------

\*Total Balcony shade area not to exceed 24 square feet. \*\*Total Balcony shade area not to exceed 18 square feet. Balcony shades can be mounted on their side. Use vertical measurement as your width (max 36") and the horizontal measurement as your length (max 48"). \*\*\*Soprano Skylight minimum installation angle of 5 degrees. Maximum installation angle of 85 degrees. Horizontal (0 degrees) and vertical (90 degrees) applications are not recommended. \*\*\*All Soprano Greenhouse shade orders require a completed and signed greenhouse shade order form. Orders must be faxed to Comfortex for processing. Download a copy of the order form at [www.comfortex.com/comfortex-dealers](http://www.comfortex.com/comfortex-dealers).



Comfortex Skylight and Greenhouse Shades

PRICING

SPECIALTY SHAPED SHADES

**LIGHT FILTERING FABRICS**

Boutique 3/4" Light Filtering  
Linen Weave 3/4" Light Filtering

Verona 3/4" Light Filtering  
Aspen 3/8" Double Cell Light Filtering

**Price Group 30  
Soprano Skylights**

		Width In Inches					
		26	30	34	38	42	48
Length In Inches	30	543	579	617	652	688	729
	36	587	629	669	709	750	792
	42	631	679	722	766	813	859
	48	679	729	778	822	872	926
	54	722	781	831	880	931	989
	60	770	831	883	939	991	1054
	72	862	925	989	1053	1116	1189
	84	954	1026	1101	1169	1238	1321
	96	1050	1126	1206	1283	1364	1457
	108	1142	1228	1311	1396	1482	1583
	120	1238	1325	1422	1514	1606	1717
	132	1328	1428	1528	1628	1729	1846
	144	1413	1529	1637	1746	1850	1981
	156	1504	1630	1746	1859		
	168	1593	1733	1853	1973		
180	1680	1837	1959	2087			

**ROOM DARKENING FABRICS**

Boutique 3/4" Room Darkening  
Linen Weave 3/4" Room Darkening  
Verona 3/4" Room Darkening

**Price Group 31  
Soprano Skylights**

		Width In Inches					
		26	30	34	38	42	48
Length In Inches	30	706	753	803	848	895	948
	36	764	818	870	922	975	1030
	42	821	883	939	996	1057	1117
	48	883	948	1012	1069	1134	1204
	54	939	1016	1081	1144	1211	1286
	60	1001	1081	1148	1221	1289	1371
	72	1121	1203	1286	1369	1451	1546
	84	1241	1334	1432	1520	1610	1718
	96	1365	1464	1568	1668	1774	1895
	108	1485	1597	1705	1815	1927	2058
	120	1610	1723	1849	1969	2088	2233
	132	1727	1857	1987	2117	2248	2400
	144	1837	1988	2129	2270	2405	2576
	156	1956	2119	2270	2417		
	168	2071	2253	2409	2565		
180	2184	2389	2547	2714			

FABRIC SURCHARGES		ADD
Scotchgard Stain Protector		\$38
Debut 1/2" Single Cell Print Fabric	Includes: Homespun, Country Woven, Florance, Strata, Angel Hair, Blossom, Terrazzo and Strie	20%
Symphony Fabric	Symphony Prints and Duotones	20%
	Symphony Double Cell Flame Resistant	30%
HARDWARE UPGRADE SURCHARGES* AND ACCESSORIES		ADD
Two Moving Rails		\$136
6 Foot Expandable Pole		\$44
12 Foot Expandable Pole		\$54

Comfortex Skylight and Greenhouse Shades

PRICING

SPECIALTY SHAPED SHADES

**LIGHT FILTERING FABRICS**

Debut 1/2" Single Cell

Symphony 3/8" Double Cell

Aspen 3/8" Double Cell

**PRICE GROUP 32**  
Balcony Skylight Shading System

		Width In Inches				
		24	30	36	42	48
Length In Inches	36	347	396	441	494	538
	42	367	421	479	531	590
	48	386	451	508	570	633
	54	412	478	542	605	687
	60	427	506	574	643	736
	66	451	529	604	676	785
	72	478	558	630	705	828
	78	506	579	660	736	
	84	534	607	688	766	
	90	569	630	717		
96	596	657	747			

All fabrics are not available in all widths, lengths and applications. Refer to Size Specifications on page 35 for availability.

Product Information: See page 80 for detailed information.

- Shades are built with color coordinating hardware and white track.
- Designer metallic and fabric wrapped rails are available.

FABRIC SURCHARGES		ADD
Scotchgard Stain Protector		\$38
Debut 1/2" Single Cell Print Fabric	Includes: Homespun, Country Woven, Florance, Strata, Angel Hair, Blossom, Terrazzo and Strie	20%
Symphony Fabric	Symphony Prints and Duotones	20%
	Symphony Double Cell Flame Resistant	30%
HARDWARE UPGRADE SURCHARGES AND ACCESSORIES		ADD
Metallic Hardware or Fabric Wrapped Rails		\$24
6 Foot Expandable Pole		\$44
12 Foot Expandable Pole		\$54

# Comfortex Skylight and Greenhouse Shades

## PRICING

SPECIALTY SHAPED SHADES

### BLACKOUT FABRICS

Symphony <sup>3</sup>/<sub>8</sub>"

### PRICE GROUP 33 Balcony Skylight Shading System

		Width In Inches				
		24	30	36	42	48
Length In Inches	36	452	515	574	643	700
	42	478	548	623	691	767
	48	502	587	661	741	823
	54	536	622	705	787	894
	60	556	658	747	836	957
	66	587	688	786	879	1021
	72	622	726	819	917	1077
	78	658	753	858	957	
	84	695	790	895	996	
	90	740	819	933		
96	775	855	972			

**Product Information:** See page 80 for detailed information.

- Shades are built with color coordinating hardware and white track.
- Designer metallic and fabric wrapped rails are available.

FABRIC SURCHARGES		ADD
Scotchgard Stain Protector		\$38
Symphony Fabric	Symphony Prints and Duotones	Add 20%
	Symphony Double Cell Flame Resistant	Add 30%
HARDWARE UPGRADE SURCHARGES AND ACCESSORIES		ADD
Metallic Hardware or Fabric Wrapped Rails		\$24
6 Foot Expandable Pole		\$44
12 Foot Expandable Pole		\$54

**Comfortex Skylight and Greenhouse Shades**  
**PRICING**

**SPECIALTY SHAPED SHADES**

**LIGHT FILTERING FABRICS**

Boutique 3/4"  
 Debut 1/2" Single Cell  
 Debut 1/2" Double Cell  
 Debut 3/4" Single Cell  
 Linen Weave 3/4"

Premiere 1/2"  
 Premiere 3/4"  
 Aspen 3/8"  
 Symphony 3/8"  
 Verona 3/4"

**PRICE GROUP 34**  
**Mezzo Motorized Skylights -**  
**White Rail and White Tracks**

		Width In Inches				
		24	30	36	42	48
Length In Inches	36	433	493	551	618	671
	42	460	525	598	663	737
	48	485	564	635	711	791
	54	514	597	678	756	856
	60	534	630	716	804	920
	66	564	660	753	846	981
	72	597	699	787	880	1035

Be sure to add the Simplicity motor surcharges and upgrades to the grid above. Shades and motors are priced separately to ensure that percent surcharges apply only to the shade and not the motor.

**Product Information:** See page 82 for detailed information.

- Mezzo Shades are built with white rail and white track.

<b>FABRIC SURCHARGES</b>		<b>ADD</b>
Scotchgard Stain Protector		\$38
Debut 1/2" Single Cell Print Fabric	Includes: Homespun, Country Woven, Florance, Strata, Angel Hair, Blossom, Terrazzo and Strie	20%
Debut 1/2" Double Cell Print Fabric Debut 3/4" Single Cell Print Fabric	Includes: Homespun, Country Woven, Florance, Strata and Angel Hair	20%
Premiere Fabric	Includes: Homespun, Country Woven, Florance, Spheres, Strata, Tuscan Scroll, Angel Hair, Blossom, and Gradients	20%
Symphony Fabric	Symphony Prints and Duotones	20%
	Symphony Double Cell Flame Resistant	30%
<b>MOTORIZATION - HARDWARE UPGRADE SURCHARGES AND ACCESSORIES</b>		<b>MORE INFO</b>
Simplicity - Motor and Rechargeable Battery Pack		Pg 57
Simplicity 5 Channel Remote		Pg 59
Simplicity 6 Channel Remote with Timer		Pg 59
Simplicity 14 Channel White Remote		Pg 61
48" Extension Wire:		Pg 61
Simplicity Smart Controller (NEO)		Pg 64
7.4v Solar Panel & Mounting Brackets		Pg 83
Plug-In Charger for 7.4V Li-Ion Rechargeable Battery Pack		Pg 83
		<b>ADD</b>
		\$368
		\$41
		\$67
		\$67
		\$18
		\$336
		\$105
		\$28

# Comfortex Skylight and Greenhouse Shades

## PRICING

SPECIALTY SHAPED SHADES

### ROOM DARKENING & BLACKOUT FABRICS

Boutique 3/4"  
 Linen Weave 3/4"  
 Premiere 1/2"

Premiere 3/4"  
 Symphony 3/8"  
 Verona 3/4"

### PRICE GROUP 35 Mezzo Motorized Skylights - White Rail and White Tracks

		Width In Inches				
		24	30	36	42	48
Length In Inches	36	563	641	717	804	873
	42	598	683	778	862	959
	48	631	734	826	925	1029
	54	668	777	882	983	1113
	60	694	819	931	1046	1196
	66	733	858	979	1100	1276
	72	776	909	1024	1144	1346

Be sure to add the Simplicity motor surcharges and upgrades to the grid above.

**Product Information:** See page 82 for detailed information.

- Mezzo Shades are built with white rail and white track.

FABRIC SURCHARGES		ADD	
Scotchgard Stain Protector		\$38	
Premiere Fabric	Includes: Homespun, Country Woven, Florance, Spheres, Strata, Tuscan Scroll, Angel Hair, Blossom, and Gradients	Add 20%	
MOTORIZATION - HARDWARE UPGRADE SURCHARGES AND ACCESSORIES		MORE INFO	ADD
Simplicity - Motor and Rechargeable Battery Pack		Pg 57	\$319
Simplicity 5 Channel Remote		Pg 59	\$41
Simplicity 6 Channel Remote with Timer		Pg 59	\$67
Simplicity 14 Channel White Remote		Pg 61	\$67
48" Extension Wire:		Pg 61	\$18
Simplicity Smart Controller (NEO)		Pg 64	\$336
7.4v Solar Panel & Mounting Brackets		Pg 83	\$105
Plug-In Charger for 7.4V Li-Ion Rechargeable Battery Pack		Pg 83	\$28

**Comfortex Skylight and Greenhouse Shades**

**PRICING**

**SPECIALTY SHAPED SHADES**

**Prelude 3/4" Light Filtering**

**PRICE GROUP 36**  
**Skylight Shading System**

		Width In Inches						
		24	30	36	42	48	54	60
Length In Inches	36	313	357	397	445	485	558	642
	42	331	379	432	478	531	611	703
	48	348	406	458	513	570	656	755
	54	371	431	488	545	619	712	819
	60	385	456	517	579	663	763	878
	66	406	477	544	609	707	814	937
	72	431	503	567	635	746	858	987

**Prelude 3/4" Blackout**

**PRICE GROUP 37**  
**Skylight Shading System**

		Width In Inches						
		24	30	36	42	48	54	60
Length In Inches	36	423	482	536	601	655	754	867
	42	447	512	584	646	717	825	950
	48	470	549	619	693	770	886	1020
	54	501	582	659	736	836	962	1106
	60	520	616	698	782	896	1031	1186
	66	549	644	735	823	955	1099	1265
	72	582	680	766	858	1008	1159	1333

**Product Information:** See page 106 for detailed information.

<b>HARDWARE UPGRADE SURCHARGES AND ACCESSORIES</b>		<b>ADD</b>
6 Foot Expandable Pole		\$44

French Door Décor Shades  
**SIZE STANDARDS**

SPECIALTY SHAPED SHADES

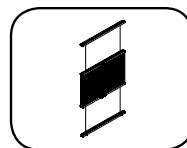
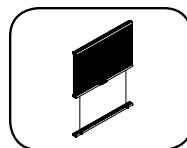
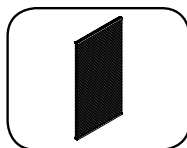

		Door Decor Non-Movable	Door Decor Movable	Door Decor Top Down-Bottom Up	
ALL FABRICS	Minimum Width	6"	6"		6"
	Minimum Length	12"	12"		12"

Light Filtering	Price Group	Page		Door Decor Non-Movable	Door Decor Movable	Price Group Page	Door Decor Top Down-Bottom Up	Price Group Page
Verona 3/4"	37	43	Maximum Width & Length	36" x 96"	36" x 96"	38 Page 44	36" x 96"	38 Page 44
Boutique 3/4"				36" x 96"	36" x 96"		36" x 96"	
Debut 1/2" Single				36" x 96"	36" x 96"		36" x 96"	
Debut 1/2" Double				36" x 96"	36" x 96"		36" x 96"	
Debut 3/4"				36" x 96"	36" x 96"		36" x 96"	
Linen Weave 3/4"				36" x 96"	36" x 96"		36" x 96"	
Premiere 1/2"				36" x 96"	36" x 96"		36" x 96"	
Premiere 3/4"				36" x 96"	36" x 96"		36" x 96"	
Aspen 3/8"				36" x 96"	36" x 96"		36" x 96"	
Symphony 3/8"	36" x 96"	36" x 96"	36" x 96"					

Room Darkening & Blackout	Price Group Page	Page		Door Decor Non-Movable	Door Decor Movable	Price Group Page	Door Decor Top Down-Bottom Up	Price Group Page
Verona 3/4"	39	45	Maximum Width & Length	36" x 96"	36" x 96"	40 Page 46	36" x 96"	40 Page 46
Boutique 3/4"				36" x 96"	36" x 96"		36" x 96"	
Linen Weave 3/4"				36" x 96"	36" x 96"		36" x 96"	
Premiere 1/2"				36" x 96"	36" x 96"		36" x 96"	
Premiere 3/4"				36" x 96"	36" x 96"		36" x 96"	
Symphony 3/8"				36" x 96"	36" x 96"		36" x 96"	

	Door Decor Non-Movable	Door Decor Movable	Door Decor Top Down-Bottom Up
More Information On Page	Page 85	Page 85	Page 85

**French Door Décor Shades**

**PRICING**

**SPECIALTY SHAPED SHADES**

**LIGHT FILTERING FABRICS**

- |                                   |                          |
|-----------------------------------|--------------------------|
| Boutique $\frac{3}{4}$ "          | Premiere $\frac{1}{2}$ " |
| Debut $\frac{1}{2}$ " Single Cell | Premiere $\frac{3}{4}$ " |
| Debut $\frac{1}{2}$ " Double Cell | Aspen $\frac{3}{8}$ "    |
| Debut $\frac{3}{4}$ " Single Cell | Symphony $\frac{3}{8}$ " |
| Linen Weave $\frac{3}{4}$ "       | Verona $\frac{3}{4}$ "   |

**PRICE GROUP 38**  
**Non-Movable French Door Décor**

		Width In Inches		
		<b>24</b>	<b>30</b>	<b>36</b>
Length In Inches	<b>36</b>	112	126	143
	<b>42</b>	120	137	153
	<b>48</b>	127	146	167
	<b>54</b>	135	155	180
	<b>60</b>	144	166	190
	<b>66</b>	152	177	204
	<b>72</b>	159	185	215
	<b>78</b>	167	195	225
	<b>84</b>	173	205	236
	<b>90</b>	182	214	248
<b>96</b>	187	222	259	

**Product Information:** See page 85 for detailed information.

<b>FABRIC SURCHARGES</b>		<b>ADD</b>
Scotchgard Stain Protector		\$38
Debut $\frac{1}{2}$ " Single Cell Print Fabric	Includes: Homespun, Country Woven, Florance, Strata, Angel Hair, Blossom, Terrazzo and Strie	20%
Premiere Fabric	Includes: Homespun, Country Woven, Florance, Spheres, Strata, Tuscan Scroll, Angel Hair, Blossom, and Gradients	20%
Symphony Fabric	Symphony Prints and Duotones	20%
	Symphony Double Cell Flame Resistant	30%
<b>HARDWARE UPGRADE SURCHARGES AND ACCESSORIES</b>		<b>ADD</b>
Metallic Hardware or Fabric Wrapped Rails		\$24
6 Foot Expandable Pole		\$44
12 Foot Expandable Pole		\$54



**French Door Décor Shades**

**PRICING**

**SPECIALTY SHAPED SHADES**

**LIGHT FILTERING FABRICS**

Boutique <sup>3/4"</sup>  
 Debut <sup>1/2"</sup> Single Cell  
 Debut <sup>1/2"</sup> Double Cell  
 Debut <sup>3/4"</sup> Single Cell  
 Linen Weave <sup>3/4"</sup>

Premiere <sup>1/2"</sup>  
 Premiere <sup>3/4"</sup>  
 Aspen <sup>3/8"</sup>  
 Symphony <sup>3/8"</sup>  
 Verona <sup>3/4"</sup>

**PRICE GROUP 39**  
**Movable French Door Décor**

		Width In Inches		
		24	30	36
Length In Inches	36	200	225	256
	42	215	245	277
	48	228	263	300
	54	243	279	320
	60	259	298	344
	66	274	316	366
	72	287	334	386
	78	300	352	406
	84	311	367	426
	90	327	383	447
96	338	399	465	

**Product Information:** See page 85 for detailed information.

<b>FABRIC SURCHARGES</b>		<b>ADD</b>
Scotchgard Stain Protector		\$38
Debut <sup>1/2"</sup> Single Cell Print Fabric	Includes: Homespun, Country Woven, Florance, Strata, Angel Hair, Blossom, Terrazzo and Strie	20%
Premiere Fabric	Includes: Homespun, Country Woven, Florance, Spheres, Strata, Tuscan Scroll, Angel Hair, Blossom, and Gradients	20%
Symphony Fabric	Symphony Prints and Duotones	20%
	Symphony Double Cell Flame Resistant	30%
<b>HARDWARE UPGRADE SURCHARGES AND ACCESSORIES</b>		<b>ADD</b>
Top Down-Bottom Up		\$175
Metallic Hardware or Fabric Wrapped Rails		\$24
6 Foot Expandable Pole		\$44
12 Foot Expandable Pole		\$54

**French Door Décor Shades**  
**PRICING**

**SPECIALTY SHAPED SHADES**

**ROOM DARKENING & BLACKOUT FABRICS**

Boutique 3/4"  
 Linen Weave 3/4"  
 Premiere 1/2"

Premiere 3/4"  
 Symphony 3/8"  
 Verona 3/4"

**PRICE GROUP 40**  
**Non-Movable French Door Décor**

		Width In Inches		
		24	30	36
Length In Inches	36	146	164	186
	42	156	179	199
	48	166	190	218
	54	176	202	234
	60	188	216	247
	66	198	231	266
	72	207	241	280
	78	218	254	293
	84	225	267	307
	90	237	279	323
96	244	289	337	

**Product Information:** See page 85 for detailed information.

<b>FABRIC SURCHARGES</b>		<b>ADD</b>
Scotchgard Stain Protector		\$38
Premiere Fabric	Includes: Homespun, Country Woven, Florance, Spheres, Strata, Tuscan Scroll, Angel Hair, Blossom, and Gradients	20%
Symphony Fabric	Symphony Prints and Duotones	20%
	Symphony Double Cell Flame Resistant	30%
<b>HARDWARE UPGRADE SURCHARGES AND ACCESSORIES</b>		<b>ADD</b>
Metallic Hardware or Fabric Wrapped Rails		\$24
6 Foot Expandable Pole		\$44
12 Foot Expandable Pole		\$54

**French Door Décor Shades**

**PRICING**

**SPECIALTY SHAPED SHADES**

**ROOM DARKENING & BLACKOUT FABRICS**

Boutique 3/4"  
 Linen Weave 3/4"  
 Premiere 1/2"

Premiere 3/4"  
 Symphony 3/8"  
 Verona 3/4"

**PRICE GROUP 41**  
**Movable French Door Décor**

		Width In Inches		
		24	30	36
Length In Inches	36	260	293	333
	42	280	319	361
	48	297	342	390
	54	316	363	416
	60	337	388	448
	66	357	411	476
	72	374	435	502
	78	390	458	528
	84	405	478	554
	90	426	498	582
96	440	519	605	

**Product Information:** See page 85 for detailed information.

<b>FABRIC SURCHARGES</b>		<b>ADD</b>
Scotchgard Stain Protector		\$38
Premiere Fabric	Includes: Homespun, Country Woven, Florance, Spheres, Strata, Tuscan Scroll, Angel Hair, Blossom, and Gradients	20%
Symphony Fabric	Symphony Prints and Duotones	20%
	Symphony Double Cell Flame Resistant	30%
<b>HARDWARE UPGRADE SURCHARGES AND ACCESSORIES</b>		<b>ADD</b>
Top Down-Bottom Up		\$175
Metallic Hardware or Fabric Wrapped Rails		\$24
6 Foot Expandable Pole		\$44
12 Foot Expandable Pole		\$54

Cellular Shade Collection

STANDARD CORD LOCK SHADES HARDWARE SYSTEM

Prelude Hardware Page 90



Standard Cord Lock Rail

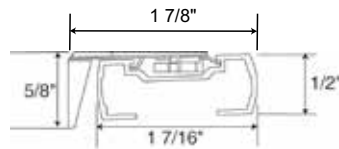

Deluxe Cord Lock Rail

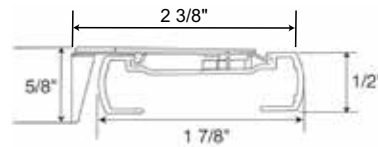

**Standard Cord Lock Rail**

- Depth of rail: 1 7/16"
- Depth of rail and bracket: 1 7/8"
- Height of rail: 1/2"
- Height of bracket: 5/8"

**Deluxe Cord Lock Rail**

- Depth of rail: 1 7/8"
- Depth of rail and bracket: 2 3/8"
- Height: 1/2"
- Height of bracket: 5/8"

**Hardware Features**

Hardware colors for Cellular fabrics	Color coordinated head and bottom rails with white cord and tassel
Standard Hardware for all Custom Graphics	White head and bottom rails with white cord and tassel

**Upgrades**

Fabric Wrapped Upgrade	Fabric used is same fabric as the shade. Back of rail is white to outside. Color coordinated end caps.
Designer Metallic Upgrade	<ul style="list-style-type: none"> <li>• Oil Rubbed Bronze head and bottom rails, bronze colored tassel, bronze end caps and white cord.</li> <li>• Brushed Nickel head and bottom rails and end caps with white cord.</li> </ul>

Mounting Dimensions	Standard Cord Lock Rail	Deluxe Cord Lock Rail
Minimum Shallow Mount	3/4"	3/4"
Minimum Flush Inside Mount	2"	2 3/8"
Minimum Outside Mount	3/4"	3/4"
Minimum Side Mount	1 1/16"	1 3/8"
Minimum Flush Side Mount	1 5/8"	1 7/8"
<b>Recommended Side Mounting Method</b>	<ul style="list-style-type: none"> <li>• See figure B for recommended mounting method for side mount shades</li> <li>• Width limit for side mount brackets is 48"</li> </ul>	

**Finished Dimensions**

**Inside and Side Mount**

- Fabric will measure ordered width less: 3/8"
- Head rail\* will measure ordered width less: 3/16"

**Outside Mount**

- Fabric will measure ordered width
- Head rail\* will measure ordered width plus: 3/16"

**Exact (End Cap to End Cap) Mount**

- Fabric will measure ordered width less: 3/16"
- Head rail\* will measure ordered width

**Cord Length**

- Comfortex complies with all WCMA/ANSI standards and as such the default cord length will be 40% of the ordered shade length. Custom lengths are available.

\* Head rail measurements include endcaps. Width and length measurements may vary +/- 1/8"

CELLULAR HARDWARE

# Cellular Shade Collection

## STANDARD CORD LOCK SHADES HARDWARE SYSTEM

Prelude Hardware Page 90

### There are two sizes of the cord lock hardware: Standard and Deluxe.

Standard size hardware is used on all fabrics except ¾" Premiere, Linen Weave, Debut, Verona and Boutique Fabrics which use the Deluxe size.

- Standard Rectangular
- Two-On-One Head Rail
- Door Decor
- SlumberShades
- Top Down - Bottom Up
- Day-Night
- Specialty Shapes
- Balcony

Deluxe Hardware is standard on ¾" Premiere, Linen Weave, Debut, Verona and Boutique Fabrics.

- Standard Rectangular
- SlumberShades
- Two-On-One Head Rail
- Top Down - Bottom Up
- Specialty Shapes

### Highlights Cornice Valance

Add a designer finishing touch to a cellular shade with a Highlights Cornice Valance. See page 114 for details.

### Recommended Mounting Method for Side Mount Shades | Maximum Width 48"

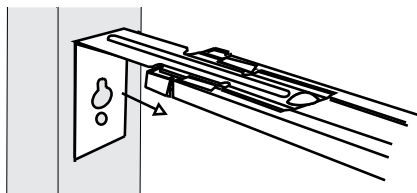

Figure B

### EZ Level on Cellular Shades

EZ Level makes quick work of leveling without cords to cut or tuck into a rail. See page 122 for details.

CELLULAR HARDWARE

### Things to Consider

- If child safety is a concern, consider cordless options: Cordless Ultra, Cordless Lift & Lock or Motorization.
- Larger shades can be difficult to operate. Consider Cord Loop, Cordless Ultra or Motorization hardware.
- If privacy is an issue, consider Top Down-Bottom Up options.

### Ordering Information Standard Cord Lock Shades

#### Standard Rectangular

- Specify IB or OB mount, rail color and left or right lift cord.

#### Top Down - Bottom Up

- Specify IB or OB mount and rail color. Middle rail will match the head and bottom rails.
- Top Down - Bottom Up Shades are made with two operating cord locks, one on the left and one on the right side of shade. The right cord operates the middle rail and left cord operates the bottom.

#### Two-On-One Head Rail

Two-On-One Head Rail Shades operate as two separate shades on one head rail.

- Specify IB or OB mount.
- Specify panel sizes.
- Maximum width in a single panel depends on fabric type. See page 11 for maximum single panel width.
- ⅜" Space between panels.
- Fabric wrapped Two-On-One Shades will have a seam in the center of the rail due to the wide width.

#### Specialties (Arches, Trapezoids, Octagons and Quarter Rounds)

See pages 107-112 for more information.

#### Balcony Skylight Shading System

See pages 80-81 for more information.

#### Door Decor

See pages 85-86 for more information.

#### Insulating SlumberShades

See pages 69-70 for more information.

#### Day-Night Shades

See pages 87-88 for more information.

# Cellular Shade Collection

## CORD LOOP HARDWARE SYSTEM

Prelude Hardware Page 92

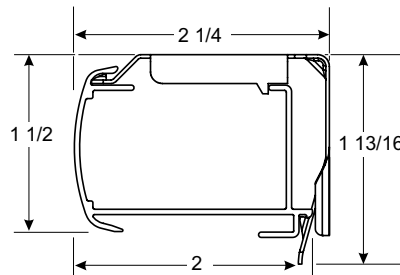

### Cord Loop Rail Dimensions

- Depth of rail: 2"
- Depth of rail and bracket: 2 1/4"
- Height of rail: 1 1/2"
- Height of bracket: 1 13/16"

CELLULAR HARDWARE

### Hardware Features

Hardware colors for Cellular fabrics	Color coordinated head, bottom rails and end caps with a white cord and tensioner
Standard Hardware for all Custom Graphics	White head and bottom rails with white cord

### Upgrades

Fabric Wrapped Upgrade	Fabric used is same fabric as the shade. Back of rail is white to outside. Color coordinated end caps for bottom rails, head rail has white clutch cover and end caps.
Designer Metallic Upgrade	<ul style="list-style-type: none"> <li>• Smooth faced Oil Rubbed Bronze head, bottom rails and end caps with bronze tensioner and bronze cord.</li> <li>• Smooth faced Brushed Nickel head, bottom rails and end caps with silver tensioner and silver cord.</li> </ul>

Mounting Dimensions	Cord Loop Hardware System
---------------------	---------------------------

Minimum Shallow Mount	1/2"
Minimum Flush Inside Mount	2 1/4"
Minimum Outside Mount	7/8"
Minimum Side Mount	1 1/4"
Minimum Flush Side Mount	2 1/4"

<b>Recommended Side Mounting Method</b>	<ul style="list-style-type: none"> <li>• See figure A for recommended mounting method for side mount shades</li> <li>• Width limit for side mount brackets is 48"</li> </ul>
---	--

### Finished Dimensions

#### Inside Mount

	<ul style="list-style-type: none"> <li>• Fabric will measure ordered width less: 3/8"</li> <li>• Head rail* will measure ordered width less: 3/16"</li> </ul>
--	---

#### Outside Mount

	<ul style="list-style-type: none"> <li>• Fabric will measure ordered width</li> <li>• Head rail* will measure ordered width plus: 3/16"</li> </ul>
--	--

#### Side Mount

	<ul style="list-style-type: none"> <li>• Fabric will measure ordered width less: 7/8"</li> <li>• Head rail* will measure ordered width less: 1 1/16"</li> </ul>
--	---

#### Exact (End Cap to End Cap) Mount

	<ul style="list-style-type: none"> <li>• Fabric will measure ordered width less: 3/16"</li> <li>• Head rail* will measure ordered width</li> </ul>
--	--

\* Head rail measurements include endcaps. Width and length measurements may vary +/- 1/8"

# Cellular Shade Collection

## CORD LOOP HARDWARE SYSTEM

Prelude Hardware Page 92

### Applications

- Standard Rectangular
- Two-On-One Head Rail
- Top Down - Bottom Up
- SlumberShades

### Cord Loop Hardware System Features

Cord loops are available 2' to 15' lengths in 1' intervals. Please specify length when ordering. Standard loop sizes are as follows:

Shade Length	Standard Loop
Up to and including 26 <sup>7</sup> / <sub>8</sub> "	1' (12")
27" to 39 <sup>7</sup> / <sub>8</sub> "	2' (24")
40" to 59 <sup>7</sup> / <sub>8</sub> "	3' (36")
60" to 83 <sup>7</sup> / <sub>8</sub> "	4' (48")
84" to 107 <sup>7</sup> / <sub>8</sub> "	5' (60")
108" and greater	6' (72")

### Recommended Mounting Method for Side Mounting Shades

Width limit for side mount brackets is 48".

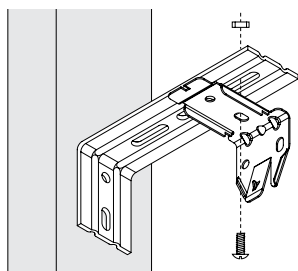

Cord Loop Hardware  
Cordless Ultra Hardware  
Cordless Ultra Top Down - Bottom Up Hardware

Figure A

Refer to the installation instructions on [Comfortex.com/comfortex-dealers](http://Comfortex.com/comfortex-dealers) or the OnDemand Mobile Library for further details on side mounting shades.

### Ordering Information for Cord Loop Hardware Shades

#### Standard Rectangular

- Specify IB or OB mount, rail color and left or right loop cord.
- Specify cord loop length when ordering.

#### Top Down - Bottom Up

- Specify IB or OB mount and rail color. Middle rail will match the top and bottom rails.
- Specify cord loop length when ordering.
- Controls are the right cord loop operates the middle rail and left cord loop operates the bottom. Reverse controls are not available.

#### Two-On-One Head Rail

- Two-On-One Head Rail Shades operate as two separate shades on one head rail.
- Specify IB or OB mount and rail color.
- Specify panel sizes.
- Specify cord loop length when ordering.
- Maximum width in a single panel depends on fabric type. See page 5 for maximum single panel width.
- <sup>3</sup>/<sub>8</sub>" Space between panels.
- Fabric wrapped Two-On-One Shades will have a seam in the center of the rail due to the wide width.

#### Insulating SlumberShades

See pages 69-70 for more information.

#### EZ Level on Cellular Shades

EZ Level makes quick work of leveling without cords to cut or tuck into a rail. See page 122 for details.

CELLULAR HARDWARE

# Cellular Shade Collection

## CORDLESS ULTRA HARDWARE SYSTEM

Prelude Hardware Page 94

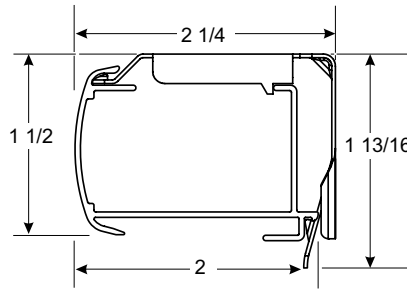

### Cord Loop Rail Dimensions

- Depth of rail: 2"
- Depth of rail and bracket: 2 1/4"
- Height of rail: 1 1/2"
- Height of bracket: 1 13/16"

CELLULAR HARDWARE

### Hardware Features

Hardware colors for all Cellular fabrics (Symphony Blackout Not Available)	Color coordinated head, bottom rails and end caps
Standard Hardware for all Custom Graphics	White head, bottom rails and end caps

### Upgrades

Fabric Wrapped Upgrade	Fabric used is same fabric as the shade. Back of rail is white to outside. End caps on fabric wrapped head and bottom rails are color coordinated
Designer Metallic Upgrade	<ul style="list-style-type: none"> <li>• Smooth faced Oil Rubbed Bronze head, bottom rails and end caps</li> <li>• Smooth faced Brushed Nickel head, bottom rails and end caps</li> </ul>

Mounting Dimensions	Cord Loop Hardware System
Minimum Shallow Mount	1/2"
Minimum Flush Inside Mount	2 1/4"
Minimum Outside Mount	7/8"
Minimum Side Mount	1 1/4"
Minimum Flush Side Mount	2 1/4"
<b>Recommended Side Mounting Method</b>	<ul style="list-style-type: none"> <li>• See figure A on page 50 for recommended mounting method for side mount shades</li> <li>• Width limit for side mount brackets is 48"</li> </ul>

### Finished Dimensions

Inside Mount	
	<ul style="list-style-type: none"> <li>• Fabric will measure ordered width less: 3/8"</li> <li>• Head rail* will measure ordered width less: 3/16"</li> </ul>
Outside Mount	
	<ul style="list-style-type: none"> <li>• Fabric will measure ordered width</li> <li>• Head rail* will measure ordered width plus: 3/16"</li> </ul>
Side Mount	
	<ul style="list-style-type: none"> <li>• Fabric will measure ordered width less: 7/8"</li> <li>• Head rail* will measure ordered width less: 1 1/16"</li> </ul>
Exact (End Cap to End Cap) Mount	
	<ul style="list-style-type: none"> <li>• Fabric will measure ordered width less: 3/16"</li> <li>• Head rail* will measure ordered width</li> </ul>

\* Head rail measurements include endcaps. Width and length measurements may vary +/- 1/8"



# Cellular Shade Collection

## CORDLESS ULTRA HARDWARE SYSTEM

Prelude Hardware Page 94

CELLULAR HARDWARE

### Applications

- Standard Rectangular
- Top Down - Bottom Up
- Insulating SlumberShades
- Two-On-One Head Rail

### Highlights Cornice Valance

Add a designer finishing touch to a cellular shade with a Highlights Cornice Valance. See page 114 for details.

### Things to Consider

- Is the top of your window out of reach? You can order an extension pole to reach but it can still be tricky. You may want to consider Cord Loop or Motorized hardware.
- For shades mounted on doors, you may want to order hold down brackets.
- If privacy is an issue, consider Top Down-Bottom Up options.

### Ordering Information for Cordless Ultra Hardware Shades

#### Standard Rectangular

- Specify IB or OB mount and rail color.

#### Top Down - Bottom Up

- Specify IB or OB mount and rail color. Middle rail will match the head and bottom rails.

#### Insulating SlumberShades

See pages 69-70 for more information.

### Accessories

- 6' Expandable Pole:
- 12' Expandable Pole:

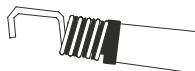

Specially designed pole end fits into the handle on the bottom rail and allows for easy operation.

### Cordless Ultra and Cordless Ultra Top Down - Bottom Up Hardware Features

- Children and pets have safer surroundings in homes that have window shades without operating cords, reducing the risk of strangulation.
- Cordless Ultra and Cordless Ultra Top Down - Bottom Up Shades can be raised or lowered with a gentle push or pull on the rail handle.
- Cordless Ultra Top Down - Bottom Up Shades feature two moving rails.
- Order an operating pole for out of reach applications.

### Cordless Ultra Shade Operation

Cordless shades should be operated from the handle located in the center of the bottom rail. Using the handle will aid in smooth and easy shade operation. Two handles are supplied on wider width shades.

To lower the shade, pull down on the handle which is secured to the bottom rail and guide the rail to desired position (Figure A). For out of reach applications, an optional extension pole should be used.

To raise the shade, push the bottom rail up using the handle on the bottom rail and guide the rail to the desired position. The shade will hold any position when the bottom rail is released. Raise the shade slowly and steadily to allow the shade to stack evenly (Figure B).

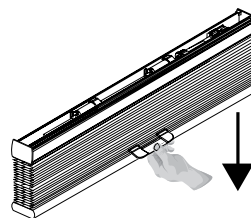

Figure A

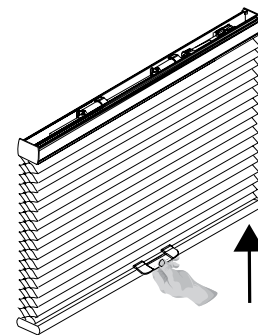

Figure B



Clear Cordless Handle

### Recommended Mounting Method for Side Mounting Shades

See Page 50.

### EZ Level on Cellular Shades

EZ Level makes quick work of leveling without cords to cut or tuck into a rail. See page 122 for details.

#### Simplicity Motorization Pricing Example:

Linen Weave	
Light Filtering 42" x 60" Shade:	\$422.00
Cordless Ultra Surcharge:	\$88.00
Scotchgard:	\$38.00
<b>Total List Price:</b>	<b>\$548.00</b>

# Cellular Shade Collection

## CORDLESS LIFT & LOCK HARDWARE SYSTEM

Prelude Hardware Page 96



### Standard Head Rail

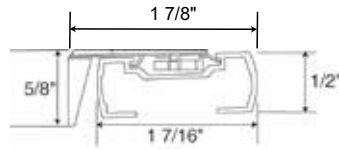

### Deluxe Head Rail

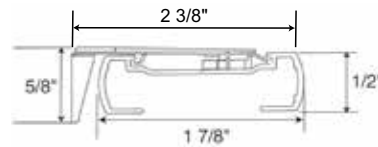

### Standard Top Rail

- Depth of rail: 1 7/16"
- Depth of rail and bracket: 1 7/8"
- Height of rail: 1/2"
- Height of bracket: 5/8"

### Deluxe Top Rail

- Depth of rail: 1 7/8"
- Depth of rail and bracket: 2 3/8"
- Height: 1/2"
- Height of bracket: 5/8"

CELLULAR HARDWARE

Hardware Features	
Hardware colors for all Cellular fabrics	Color coordinated head, middle and bottom rails with color coordinated push button/handle on the middle and bottom rails
Standard Hardware for all Custom Graphics	White head, middle and bottom rails with white cord
Upgrades	
Fabric Wrapped Upgrade	Fabric used is same fabric as the shade. Back of rail is white to outside. All shades will have a color coordinated push button and handle on the middle /bottom rail. Color coordinated end caps.
Designer Metallic Upgrade	<ul style="list-style-type: none"> <li>• Oil Rubbed Bronze head, middle, bottom rails and end caps.</li> <li>• Oil Rubbed Bronze push button/handle on the middle and bottom rails.</li> </ul>
Mounting Dimensions	
Minimum Shallow Mount	3/4"
Minimum Flush Inside Mount	2"
Minimum Outside Mount	3/4"
Minimum Side Mount	1 1/16"
Minimum Flush Side Mount	1 5/8"
<b>Recommended Side Mounting Method</b>	<ul style="list-style-type: none"> <li>• See figure A (pg 50) for recommended mounting method for side mount shades</li> <li>• Width limit for side mount brackets is 48"</li> </ul>
Finished Dimensions	
Inside and Side Mount	
	<ul style="list-style-type: none"> <li>• Fabric will measure ordered width less: 3/8"</li> <li>• Head rail* will measure ordered width less: 3/16"</li> </ul>
Outside Mount	
	<ul style="list-style-type: none"> <li>• Fabric will measure ordered width</li> <li>• Head rail* will measure ordered width plus: 3/16"</li> </ul>
Exact (End Cap to End Cap) Mount	
	<ul style="list-style-type: none"> <li>• Fabric will measure ordered width less: 3/16"</li> <li>• Head rail* will measure ordered width</li> </ul>
* Head rail measurements include endcaps. Width and length measurements may vary +/- 1/8"	

# Cellular Shade Collection

## CORDLESS LIFT & LOCK HARDWARE SYSTEM

Prelude Hardware Page 96

### Cordless Lift & Lock Shades Hardware System Bottom Rail Dimensions

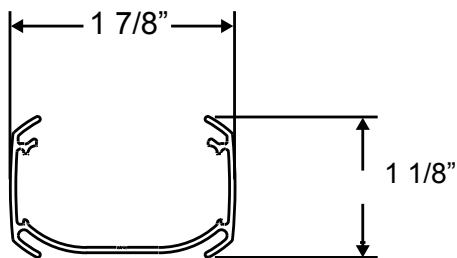

- Depth of rail: 1 7/8"
- Height of rail: 1 1/8"

#### Applications

- Standard Rectangular
- Top Down-Bottom Up
- Two-On-One Headrail

Standard size head rail hardware is used on 1/2" and 3/8" fabrics. These fabrics include: 1/2" Debut (all), 1/2" Premiere, Symphony, and Symphony Blackout.

Deluxe size head rail hardware is used on 3/4" Premiere, Linen Weave, Verona, Boutique and 3/4" Debut.

**The bottom rail is the same size for all fabrics.**

- Two-On-One headrail price as 2 separate shades and add \$52 (not available in Top Down-Bottom Up)

#### Highlights Cornice Valance

Add a designer finishing touch to a cellular shade with a Highlights Cornice Valance. See page 116 for details.

#### Important Operating Note on Cordless Lift & Lock Shades

- To operate a Cordless Lift & Lock Shade, the middle or bottom rails must be accessible. An extension pole is not available for Cordless Lift & Lock Shades.

#### Cordless Lift & Lock Hardware Features

- Children and pets have safer surroundings in homes that have window shades without operating cords, reducing the risk of strangulation.
- Cordless Lift & Lock Shades can be raised or lowered by pressing the button located on the bottom rail and guiding the rail into the desired location.

#### Leveling the Bottom Rails

Each Cordless Lift & Lock Shade includes a skew adjustment leveling tool hidden in the bottom rail of each shade.

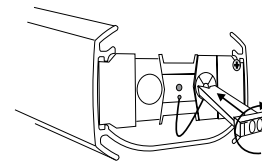

To level the bottom rail, remove the bottom rail end cap to access the tool which allows you to adjust the bottom rail. Adjustment instructions are supplied with each shade.

#### Things to Consider

- Is the top of your window out of reach? To operate a Cordless Lift & Lock Shade, the bottom rail must be accessible. If the bottom or middle rail is not accessible, you may want to consider Cord Loop, Cordless Ultra or Motorized hardware. An extension pole is not available for Cordless Lift & Lock Shades.
- For shades mounted on doors, you may want to order hold down brackets.

#### Ordering Information for Cordless Lift & Lock Shades

##### Standard Rectangular

- Specify IB or OB mount and rail color.

#### Cordless Lift & Lock Shade Operation

Cordless Lift & Lock Shades are operated using the push button handle located in the center of the bottom rail.

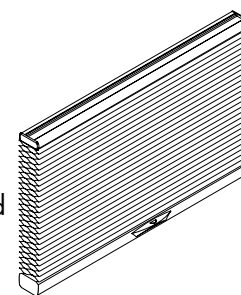

To raise or lower the shade; press the button on the shade handle, and guide the rail to desired position. Release the button to lock the shade into place.

The shade will hold in any position when the button is released. Raise the shade slowly and steadily to allow the shade to stack evenly.

CELLULAR HARDWARE

Cellular Shade Head Rail Options

**SIMPLICITY 12V NON-RECHARGEABLE MOTORIZED CELLULAR SHADES**

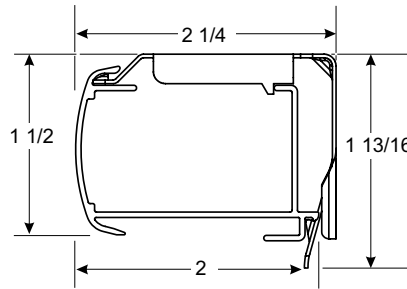

**Simplicity Motorized Rail Dimensions**

- Depth of rail: 2"
- Depth of rail and bracket: 2 1/4"
- Height of rail: 1 1/2"
- Height of bracket: 1 13/16"

**CELLULAR HARDWARE**

<b>Hardware Features</b>	
Hardware colors for all Cellular fabrics	Color coordinated head, bottom rails and end caps
Standard Hardware for all Custom Graphics	White head and bottom rails and end caps
Simplicity Remote	Upper and lower limit stops pre-programmed, Intermediate stop "favorites" position can be set on-site.

<b>Upgrades</b>	
Fabric Wrapped Upgrade	Fabric used is same fabric as the shade. Back of rail is white to outside. End caps on fabric wrapped head and bottom rails are color coordinated
Designer Metallic Upgrade	<ul style="list-style-type: none"> <li>• Smooth faced Oil Rubbed Bronze head, bottom rails and end caps</li> <li>• Smooth faced Brushed Nickel head, bottom rails and end caps</li> </ul>

<b>Mounting Dimensions</b>	<b>Simplicity Motorized Hardware System</b>
Minimum Shallow Mount	1/2"
Minimum Flush Inside Mount	2 1/4"
Minimum Outside Mount	7/8"
Minimum Side Mount	1 1/4"
<b>Recommended Side Mounting Method</b>	<ul style="list-style-type: none"> <li>• See page 50 for recommended mounting method for side mount shades</li> <li>• Width limit for side mount brackets is 48"</li> </ul>

<b>Finished Dimensions</b>	
<b>Inside Mount</b>	
	<ul style="list-style-type: none"> <li>• Fabric will measure ordered width less: 3/8"</li> <li>• Head rail* will measure ordered width less: 3/16"</li> </ul>
<b>Outside Mount</b>	
	<ul style="list-style-type: none"> <li>• Fabric will measure ordered width</li> <li>• Head rail* will measure ordered width plus: 3/16"</li> </ul>
<b>Side Mount</b>	
	<ul style="list-style-type: none"> <li>• Fabric will measure ordered width less: 7/8"</li> <li>• Head rail* will measure ordered width less: 1 1/16"</li> </ul>
<b>Exact (End Cap to End Cap) Mount</b>	
	<ul style="list-style-type: none"> <li>• Fabric will measure ordered width less: 3/16"</li> <li>• Head rail* will measure ordered width</li> </ul>

\* Head rail measurements include endcaps. Width and length measurements may vary +/- 1/8"

## Cellular Shade

### SIMPLICITY 12V NON-RECHARGEABLE MOTORIZED CELLULAR SHADES

#### Simplicity Motors

The Simplicity Motor program features a battery powered 12V motor utilizing a single battery wand or plug-in DC transformer. Simplicity motors are compact and use a radio frequency remote to raise or lower the shades.

Motorized Lift Systems are not offered on sizes within the shaded area on the Standard Rectangular price grids.

- Length measurements may vary +/- 1/8".

#### Applications

- Standard Rectangular
- Two-On-One Head Rail Bottom Up

#### EZ Level

Learn about the EZ Level feature on page 122.

#### Simplicity Motorization Surcharges

The standard Simplicity Motorized Lift System surcharge includes a 12 volt battery wand with eight AA alkaline batteries. Remotes are needed to operate the shades. See pricing pages.

#### Important Simplicity Motorized Shade Operating and Installation Information

- Simplicity Motorized Shades installed into windows with metal casings may have a reduced radio frequency range, or may not operate at all, depending on the application.
- Do not let the antenna on the motor touch any metal objects. This may interfere with signals from the remote control.

#### SIMPLICITY MOTORIZATION PRICING EXAMPLE:

Linen Weave	
Light Filtering 42" x 60" Shade:	\$422.00
Simplicity Motor Surcharge:	\$368.00
Simplicity Remote Control:	\$44.00
<b>Total List Price:</b>	<b>\$834.00</b>

#### Simplicity Battery Wand

Batteries are needed to operate Simplicity motors. The battery wand can be clipped to the head rail or wall or ceiling mounted utilizing white battery wand clips. The 12 volt battery wand measures 17 1/4", and comes with eight AA alkaline batteries, and is white in color.

The battery wire is 10" long. A 48" extension wire is available.



#### Simplicity Motor Battery Life and Replacement

Eight alkaline batteries are included with the wand. The battery life will vary based on the type of window covering selected, the size and weight of the window covering and the number of times you operate the shade on a daily basis. For example, a 36" x 60" single honeycomb shade operated twice daily will commonly have a battery life which lasts up to 18 months.

Comfortex will warranty batteries for up to 3 months from date of purchase.

#### Simplicity Hand Held Remotes

The **5 Channel (5C) remote** can operate up to five shades individually or 5 groups. Simplicity Rechargeable Motorized Cellular Shades are programmed at the factory with the "up and down" limits. The shades are **UNLINKED** from the remote so they are not able to operate during shipping. Each shade should be installed **after** linking it to the remote.



Simplicity 5C remotes and holders are white or black in color. The remote comes with a holder which can be mounted to a wall for easy storage. The range of the remote is approximately 80 feet.

A **6 Channel (6C) timer remote** is also available. See page 65 for more information.

#### DC Power Supply/Transformer

12 Volt DC power supply/transformer is available and requires a standard power outlet to power the motor. The transformer is an alternative to a battery wand. Each transformer can power a single shading. The power supply must plug in to the motor. The DC power supply is white and comes with a 80" wire. The dimensions are 1 7/8" wide x 3 1/4" long x 1 1/4" deep



#### 12V Simplicity Low Voltage Hardwiring System

Learn about the 12V Low Voltage Hardwiring System on page 63.

Cellular Shade Collection

7.4V RECHARGEABLE SIMPLICITY MOTORIZED HARDWARE SYSTEM \_\_\_\_\_

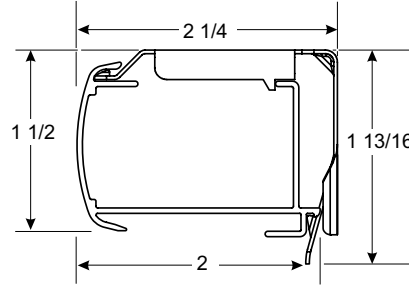

**Rechargeable Simplicity Rail Dimensions**

- Depth of rail: 2"
- Depth of rail and bracket: 2 1/4"
- Height of rail: 1 1/2"
- Height of bracket: 1 13/16"

<b>Hardware Features</b>	
Hardware colors for all Cellular fabrics	Color coordinated head, bottom rails and end caps
Standard Hardware for all Custom Graphics	White head and bottom rails and end caps
<b>Upgrades</b>	
Fabric Wrapped Upgrade	Fabric used is same fabric as the shade. Back of rail is white to outside. End caps on fabric wrapped head, middle and bottom rails are color coordinated
Designer Metallic Upgrade	<ul style="list-style-type: none"> <li>• Smooth faced Oil Rubbed Bronze head, middle, bottom rails and end caps</li> <li>• Smooth faced Brushed Nickel head, middle, bottom rails and end caps</li> </ul>
<b>Mounting Dimensions</b>	
<b>Rechargeable Simplicity Motorization Hardware System</b>	
Minimum Shallow Mount	1/2"
Minimum Flush Inside Mount	2 1/4"
Minimum Outside Mount	7/8"
Minimum Side Mount	1 1/4"
Minimum Flush Side Mount	2 1/4"
<b>Recommended Side Mounting Method</b>	<ul style="list-style-type: none"> <li>• See page 50 for recommended mounting method for side mount shades</li> <li>• Width limit for side mount brackets is 48"</li> </ul>
<b>Finished Dimensions</b>	
<b>Inside Mount</b>	
	<ul style="list-style-type: none"> <li>• Fabric will measure ordered width less: 3/8"</li> <li>• Head rail* will measure ordered width less: 3/16"</li> </ul>
<b>Outside Mount</b>	
	<ul style="list-style-type: none"> <li>• Fabric will measure ordered width</li> <li>• Head rail* will measure ordered width plus: 3/16"</li> </ul>
<b>Side Mount</b>	
	<ul style="list-style-type: none"> <li>• Fabric will measure ordered width less: 7/8"</li> <li>• Head rail* will measure ordered width less: 1 1/16"</li> </ul>
<b>Exact (End Cap to End Cap) Mount</b>	
	<ul style="list-style-type: none"> <li>• Fabric will measure ordered width less: 3/16"</li> <li>• Head rail* will measure ordered width</li> </ul>
* Head rail measurements include endcaps. Width and length measurements may vary +/- 1/8"	

CELLULAR HARDWARE

## Cellular Shade Collection

### 7.4V RECHARGEABLE SIMPLICITY MOTORIZED HARDWARE SYSTEM

#### Rechargeable Simplicity Motors

The Simplicity Motor program features a battery powered motor utilizing a rechargeable battery hidden inside the shade head rail. Simplicity motors are compact and use a radio frequency remote to raise or lower the shades.

Rechargeable Motorized Lift Systems are not offered on sizes within the shaded area on the Standard Rectangular price grids.

#### Applications

- Standard Rectangular
- Top Down-Bottom Up see page 60
- Two-On-One Head Rail Bottom Up
- Two-On-One Head Rail Top Down-Bottom Up

#### EZ Level

Learn about the EZ Level feature on page 122.

#### Rechargeable Simplicity Motorization Surcharges

The Rechargeable Simplicity Motorized Lift System surcharge includes a rechargeable battery. Remotes are needed to operate the shades. Refer to pricing pages.

#### Important Simplicity Motorized Shade Operating and Installation Information

- Simplicity Motorized Shades installed into windows with metal casings may have a reduced radio frequency range, or may not operate at all, depending on the application.
- Do not let the antenna on the motor touch any metal objects. This may interfere with signals from the remote control.

#### Simplicity Rechargeable Battery

The rechargeable battery is concealed in the head rail of the shade. A charger is required for the rechargeable battery. The rechargeable battery comes fully charged from the factory.

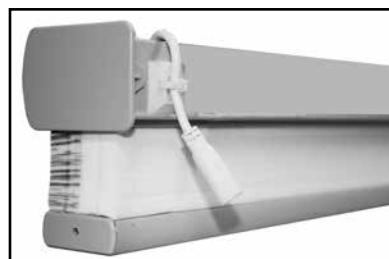

Charging Port on Back of Head rail.

#### Solar Panel Recharge Option

Plugs in to any Simplicity Rechargeable Remote control shade (does not work with PowerTouch)

Provides constant trickle charge to 7.4v Li-Ion Rechargeable battery packs. Does not require direct sunlight, but performs best in regular direct sunlight applications. Will prolong the life of the charge of the 7.4v rechargeable battery packs, and in some applications will maintain charge indefinitely.

Life of charge is subject to application variables such as, size and weight of shade, frequency of use, amount of direct sunlight exposure, etc.



Dimensions of panel  
18½" x 1½"

CELLULAR HARDWARE

#### RECHARGEABLE SIMPLICITY PRICING EXAMPLE:

Linen Weave	
Light Filtering 42" x 60" Shade:	\$422.00
Simplicity Rechargeable Surcharge:	\$368.00
Charger for Rechargeable :	\$30.00
Simplicity Remote Control:	\$44.00
<b>Total List Price:</b>	<b>\$864.00</b>

## Cellular Shade Collection

### 7.4V RECHARGEABLE SIMPLICITY MOTORIZED HARDWARE SYSTEM

#### Simplicity Rechargeable Battery Life

Rechargeable batteries are included with the motor.

The average battery charge will last 6-12 months based on an average sized shade raised and lowered once per day. The life of the battery charge will vary based on the type of window covering selected, the size and weight of the window covering and the number of times the shade is operated on a daily basis.

The battery can be recharged up to 500 times. It takes approximately 5 hours to recharge the motor when fully depleted.

#### Ordering Information for Rechargeable Motorized Cellular Shades

##### Simplicity Motor Option

- Specify IB or OB mount and rail color.
- Specify remote and other accessories if needed.
- Specify one or more battery chargers.

##### Please Note:

- Not all motors run at the same rate of speed.
- Simplicity motors have a "Favorites" position setting. If the homeowner wants to set several shades at the same intermediate position, follow instructions provided with installation manual.
- Simplicity Rechargeable Motorized Cellular Shades are programmed at the factory with the "up and down" limits. The shades are **UNLINKED** from the remote so they are not able to operate during shipping. Each shade should be installed **after** linking it to the remote.
- The Simplicity remotes utilize one 3V battery. Batteries are included. Comfortex will warranty batteries for up to 3 months from date of purchase. Remote batteries are not covered by the warranty.
- **REMEMBER: Order at least one charger if ordering rechargeable motors.**

#### Simplicity Motorized Shade Warranty

Please see page 128 for complete Comfortex warranty information.

#### Battery Charger

8.4 Volt charger requires a standard power outlet to recharge the battery wand. Must specify charger when ordering a Simplicity Rechargeable Wand Shade. The charger plugs into the charger port. The charger is black and comes with a 156" wire. The dimensions are 1" wide x 2½" length x 1¾" deep.



#### 5 Channel Remote Control

The **5 Channel (5C) remote** can operate up to five shades individually or 5 groups. Simplicity Rechargeable Motorized Cellular Shades are programmed at the factory with the "up and down" limits. The shades are **UNLINKED** from the remote so they are not able to operate during shipping. Each shade should be installed **after** linking it to the remote.

Simplicity 5C remotes and holders are white or black in color. The remote comes with a holder which can be mounted to a wall for easy storage. The range of the remote is approximately 80 feet.



#### 6 Channel Timer Remote Control

The **6 Channel (6C) timer remote** combines the functionality of a six channel hand-held control with the convenience of a programmable timer.

- The 6C timer remote allows for 18 different scheduled actions.
- Manual function disables the timer so then the remote operates as a held remote.

Simplicity 6C remotes and holders are white in color. The remote comes with a holder which can be mounted to a wall for easy storage. The range of the remote is approximately 80 feet.



Simplicity Rechargeable Motorized Cellular Shades are programmed at the factory with the "up and down" limits. The shades are **UNLINKED** from the remote so they are not able to operate during shipping. Each shade should be installed **after** linking it to the remote.

A **14 Channel (14C) remote** is also available. This remote is required for TDBU motorization but can be utilized on all Simplicity motorized shades. See page 58 for more information.

#### Simplicity Motor Hand Held Remotes Operation

Press the up or down button on the remote to raise or lower the shade to your desired position.

To reprogram channel assignments, please refer to the installation instructions and/or view the video at: [comfortex.com/comfortex-dealers](http://comfortex.com/comfortex-dealers).



Cellular Shade Collection

7.4V RECHARGEABLE MOTORIZED TOP DOWN-BOTTOM UP HARDWARE SYSTEM

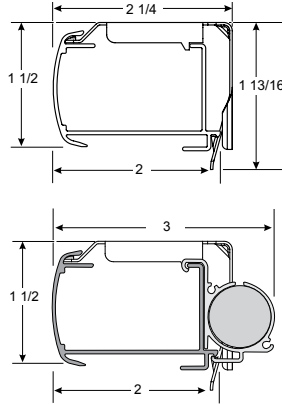

**Simplicity Motorized Rail Dimensions**

- Depth of rail: 2"
- Depth of rail and bracket: 2 1/4"
- Height of rail: 1 1/2"
- Height of bracket: 1 13/16"

**Simplicity Motorized Rail with External Battery Dimensions (shades under 36")**

- Depth of rail: 2"
- Depth of rail, bracket & battery: 3"
- Height of rail: 1 1/2"
- Height of bracket: 1 13/16"

CELLULAR HARDWARE

Hardware Features	
Standard Hardware	<ul style="list-style-type: none"> <li>• Color coordinated head, middle, and bottom rails. Head rail and Bottom rails will have frosted end caps with fabric inserts.</li> </ul>
14 Channel TDBU Remote	Upper and lower limit stops pre-programmed
Upgrades	
Designer Metallic Upgrade	<ul style="list-style-type: none"> <li>• Smooth faced Designer Oil Rubbed Bronze head, middle, bottom rails and end caps</li> <li>• Smooth faced Designer Brushed Nickel head, middle, bottom rails and end caps</li> </ul>
Fabric Wrapped Rails	<ul style="list-style-type: none"> <li>• Fabric used to cover the rails is the same fabric as the shade. The back of the rail will be white to the outside. End Caps will be color coordinated.</li> </ul>

Mounting Dimensions	Simplicity Motorized Hardware System
Minimum Shallow Mount	1/2"
Minimum Flush Inside Mount	2 1/4"
Minimum Outside Mount	7/8"
Minimum Side Mount	1 1/4"
<b>Recommended Side Mounting Method</b>	<ul style="list-style-type: none"> <li>• See page 50 for recommended mounting method for side mount shades</li> <li>• Width limit for side mount brackets is 48"</li> </ul>

Finished Dimensions	
Inside Mount	
	<ul style="list-style-type: none"> <li>• Fabric will measure ordered width less: 3/8"</li> <li>• Head rail* will measure ordered width less: 3/16"</li> </ul>
Outside Mount	
	<ul style="list-style-type: none"> <li>• Fabric will measure ordered width</li> <li>• Head rail* will measure ordered width plus: 3/16"</li> </ul>
Side Mount	
	<ul style="list-style-type: none"> <li>• Fabric will measure ordered width less: 7/8"</li> <li>• Head rail* will measure ordered width less: 1 1/16"</li> </ul>
Exact (End Cap to End Cap) Mount	
	<ul style="list-style-type: none"> <li>• Fabric will measure ordered width less: 3/16"</li> <li>• Head rail* will measure ordered width</li> </ul>
* Head rail measurements include endcaps. Width and length measurements may vary +/- 1/8"	

# Cellular Shade Collection

## 7.4V RECHARGEABLE MOTORIZED TOP DOWN-BOTTOM UP HARDWARE SYSTEM

### Rechargeable Simplicity Motors

The Simplicity TDBU Motor program features a battery powered motor utilizing a rechargeable battery hidden inside the shade head rail. If shades are less than 36" in width, an external snap-on battery pack is necessary. *(See picture to right)*

### Applications

- TDBU Rectangular/ Two-On-One Head Rail

### EZ Level

Learn about the EZ Level feature on page 122.

### Rechargeable Simplicity Motorization Surcharges

The Rechargeable Simplicity Motorized Lift System surcharge includes a rechargeable battery. Remotes are needed to operate the shades. Refer to pricing pages.

### Ordering Information for Top Down-Bottom Up Motorized Cellular Shades

#### Simplicity Motor Option

- Specify IB or OB mount and rail color.
- 14 Channel TDBU Remote is required.
- Specify one or more battery chargers.

#### Please Note:

- Shades that are 24"-36" in width will have an external battery.
- Shades with an external battery and OB mounted will need spacer blocks.
- Simplicity Rechargeable Motorized Cellular Shades are programmed at the factory with the "up and down" limits.
- **REMEMBER: Order at least one charger if ordering rechargeable motors.**

### Top Down-Bottom Up Simplicity Motor Hand Held 14 Channel Remote

The TDBU remote has 14-channels. Each channel has a setting able to operate the middle rail and a setting able to operate the bottom rail. The TDBU remote is required for TDBU motors, but can be used with other motors as well. The **14 Channel TDBU remote** can operate up to fourteen shades individually or 14 groups. Simplicity Rechargeable Motorized Cellular Shades are programmed at the factory with the "up and down" limits. The shades are **UNLINKED** from the remote so they are not able to operate during shipping. Each shade should be installed **after** linking it to the remote.



Simplicity TDBU remotes and holders are white in color. The remote comes with a holder which can be mounted to a wall for easy storage. The range of the remote is approximately 80 feet. A **14 Channel (14C) remote** can be utilized on all Simplicity motorized shades.

### Simplicity Rechargeable Battery for TDBU

The rechargeable battery is concealed in the head rail of the shade. A charger is required for the rechargeable battery. The rechargeable battery comes fully charged from the factory.

Rechargeable Battery Pack is concealed in the head rail. Minimum width 36" or less is required otherwise battery wand must be mounted externally.

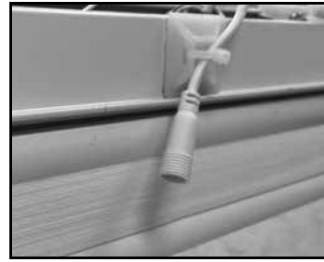

Charging Port on Back of Head rail.



Snap-On external battery for TDBU shades 36" or less in width. Spacer block also required for outside mount.

### Battery Charger

8.4 Volt charger requires a standard power outlet to recharge the battery wand. Must specify charger when ordering a Simplicity Rechargeable Wand Shade. The charger plugs into the charger port. The charger is black and comes with a 156" wire. The dimensions are 1" wide x 2½" length x 1¾" deep.



### Solar Panel Recharge Option

Plugs in to any Simplicity Rechargeable Remote control shade (does not work with PowerTouch). See page 83.



Dimensions of panel 18½" x 1½"

### MOTORIZED TOP DOWN-BOTTOM UP PRICING EXAMPLE:

Linen Weave	
Light Filtering 42" x 60" Shade:	\$422.00
Simplicity Rechargeable TDBU Surcharge:	\$589.00
Charger for Rechargeable:	\$30.00
TDBU Remote Control:	\$72.00
<b>Total List Price:</b>	<b>\$1113.00</b>

## Cellular Shade Collection

### 7.4V SIMPLICITY INTEGRATED RECHARGEABLE HARDWARE SYSTEM

#### EZ Charge Extension Wand Option

EZ Charge Extension Wand is the newest innovation in rechargeable motorization. Easily charge your hard to reach Simplicity Rechargeable Shades with the EZ Charge Extension Wand to charge. The wand extends up to 31" in length.

Simple to use! Place the magnetized wand tip to the receiving port to attach. Then plug the charger into the base of the wand. It is that simple!

- EZ Charge Extension Wand can be easily concealed by a valance or drapery panel.
- Great for out of reach windows

#### EZ Charge Wall Mount Receiver

- The EZ Charge Wall Mount Receiver includes screws and anchors. These can be used for wood or drywall mounting.
- Extension cable plugs into charging port of Simplicity Rechargeable shades.



EZ Charge Wall Mount Receiver Kit | CKIT078  
One kit per Simplicity Motorized shade is needed.

#### EZ Charge Wand

- Wand is 9 1/2" and extends to 31"  
Magnetized tip makes connection quick and easy.
- Once wand is in place plug the 8.4v charger into the bottom of the extension wand for charging.

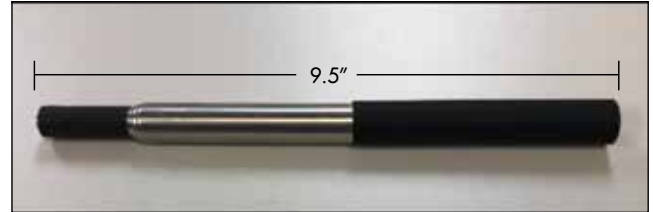

EZ Charge Wand | CKIT077  
Order with the EZ Charge Wall Mount Receiver Kit



EZ Charge Receiving Port



Port/Wand Connection

Shade/Blind Product	EZ Charge Wall Mount Receiver List Price	EZ Charge Wand List Price
Cellular	\$22	\$40



Battery Charger



Wand Base

#### Battery Charger - SOLD SEPARATELY

You must specify charger when ordering a Simplicity Rechargeable Motorized Shade. The charger plugs into the wand base. The 8.4 Volt charger requires a standard power outlet to recharge the motor. The charger is black and comes with a 156" wire. The dimensions are 1" wide x 2 1/2" length x 1 3/4" deep.

CELLULAR HARDWARE

# Cellular Shade Collection

## 12V SIMPLICITY LOW VOLTAGE HARDWIRING SYSTEM

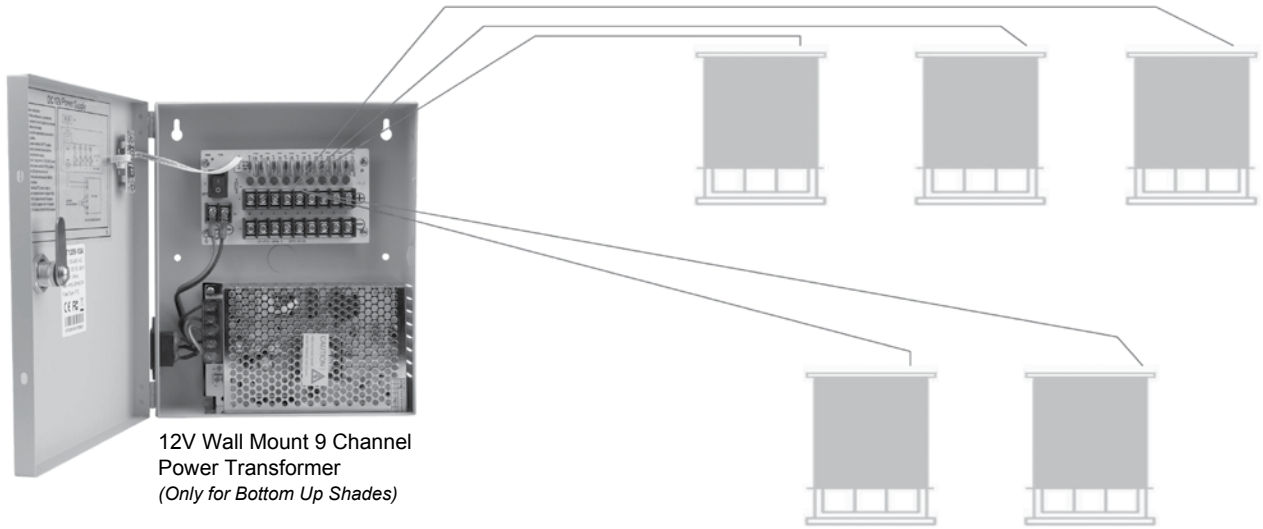

CELLULAR HARDWARE

### 12V Low Voltage Hard Wired

Low Voltage hardwire powered motors are available for Cellular bottom up shades. The system offers a maintenance-free power option for Simplicity Motorized Shades. Our Simplicity power transformer mounts in a safe dry location (such as your basement), out of sight, and provides power for up to nine individual shades per box.

2 Conductor wires (not included) should be pre-installed by a licensed contractor according to local building codes, to connect power from the transformer to the shades.

Simply connect the wire adapters provided to connect the power wire to the Simplicity motor power input on the back of the shade, then connect the pre-run wires to the (+ / -) terminal block in the transformer box, and flip on the power switch.

- Product Dimension: 7.875" wide, 9.4" Tall, 2.45" deep
- Converts incoming 120V AC to outgoing 12V to up to 9 shades.

- **Product Description:**

- 12v10a 9ch
- Input Voltage Range : AC90V-264V
- Input Frequency Range : 50Hz-60Hz
- Output Voltage Range : DC12V+/-5%
- Output Current : 10 Ampere
- Output Power : 120 Watt
- Output Ripple&Noise : ≤42MV
- Output Efficiency : ≥83%
- Output Fuse Type : PTC
- Output Fuse Rating : 2A
- Environment Operatiing Amb.Temp : -30 ~45  
20%~90%RH
- Environment Storage Temp : -40 ~85 10%~95%RH
- Plugs into standard household outlet



2 Conductor Wires (not included) running to basement 12V Power Transformer

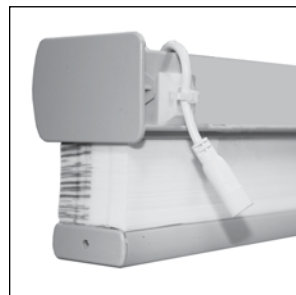

Power port on back of shade



Wires connecting to power port on Simplicity shade: supplied.



12V Wall Mount 9 Channel Power Transformer

# Cellular Shade Collection

## SIMPLICITY SMART CONTROLLER



### **Simplicity Smart Controller Dimensions**

- Width of controller: 2<sup>3</sup>/<sub>8</sub>"
- Length of controller: 2<sup>15</sup>/<sub>16</sub>"
- Height of controller: 1<sup>1</sup>/<sub>8</sub>"

CELLULAR HARDWARE

<b>Simplicity Smart Controller</b>	
	<ul style="list-style-type: none"> <li>• Works with Apple and Android devices</li> <li>• FREE Downloadable Application</li> <li>• Compatible with previously installed Simplicity Remote Control Shades</li> <li>• Powered by NEO Smart Blinds App</li> <li>• Compatible with Amazon Alexa, Google Assistant systems, Control4 and Savant systems</li> </ul>

### **Simplicity Smart Controller**

The Simplicity Smart Controller is a small device that you install in your home that allows you to set automatic opening and closing times for all Simplicity motorized shades as well as the ability to control your motorized shades from a phone, tablet or PC from anywhere in world.

The Simplicity Smart Controller will work with any Comfortex remote motorized shade with Simplicity remote control motors purchased after 2012.

The Simplicity Smart Controller plugs into a standard electrical outlet and connects to WiFi and sends signals to your shades using the same radio frequencies as a normal remote control.

### **How Does The NEO Smart Blinds App Work?**

The app uses WiFi or cellular data to send commands over the internet to the Simplicity Smart Controller.

### **Do I Need Any Other Equipment?**

Yes, The location where your shades are installed must have WiFi in order for the Simplicity Smart Controller to work. Additionally, you must have a smartphone or tablet running Android or iOS (eg. iPhone, iPad, Samsung Galaxy S7) and have the NEO Smart Blinds app. installed.

### **Why Would I Want A Simplicity Smart Controller?**

There are two main ways the Simplicity Smart Controller adds additional value to your motorized shades. First, once all of your shades have been added, you can use your smartphone as a single remote for all of your shades that will work anywhere you are regardless of distance from the shade. Secondly, the device allows you to set schedules so your motorized shades automatically open and close without needing to do anything on a day to day basis.

### **Do I Need To Buy More Than 1 Controller?**

The normal use for the Simplicity Smart Controller is to plug it in out of the way and forget it. Since it has roughly the same range as a remote you will want enough devices to allow all shades to be operated without moving the controller. So depending on the layout of the home and location of the shade, you might want multiple devices to have convenient full home coverage.

### **How Far Is The Range Of A Controller?**

You should see a range of approximately 150 ft. However this number might be less depending on the layout of your home. In general we recommend one per a floor of a normal sized home.

### **Can I Control My Shades From Multiple Devices?**

Yes! You can download the NEO Smart Blinds App. onto multiple devices, After installing the App. on a new device simply log in with the same email/password on each device and you will have access to control your shades.

### **Can It Be Used With Already Installed Shades?**

Yes! Simply follow the directions in the NEO Smart Blinds app. to add a shade. At the pairing step you can put the shade in pairing mode using the primary remote control for it (or by accessing the button on the shades motor). Adding the shade to the NEO Smart Blinds App. will not affect the normal remote operation.

### **How Much Does The NEO Smart Blinds App Cost?**

The app is a free download, However you must have at least one Simplicity Smart Controller to serve as a bridge between the app and your shades. See page 10.

Cellular Shade Collection

POWERTOUCH RECHARGEABLE MOTORIZED HARDWARE SYSTEM

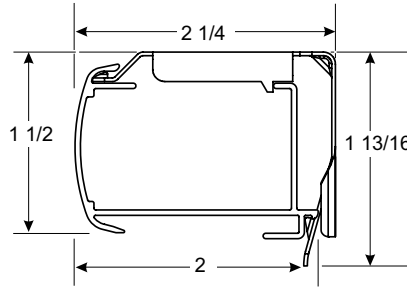
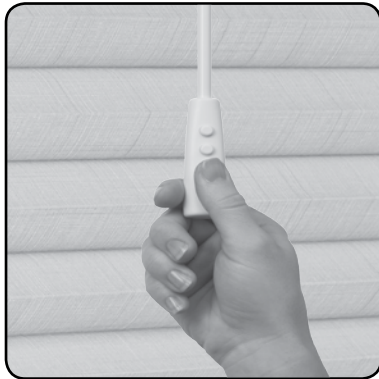

**Simplicity Motorized Rail Dimensions**

- Depth of rail: 2"
- Depth of rail and bracket: 2 1/4"
- Height of rail: 1 1/2"
- Height of bracket: 1 13/16"

Hardware Features	
Hardware colors for all Cellular and Pleated fabrics	Color coordinated head, bottom rails and end caps
Standard Hardware for all Custom Graphics	White head and bottom rails and end caps
Simplicity Remote	Upper and lower limit stops pre-programmed, Intermediate stop "favorites" position can be set on site
Upgrades	
Fabric Wrapped Upgrade	Fabric used is same fabric as the shade. Back of rail is white to outside. End caps on fabric wrapped head, middle and bottom rails are color coordinated
Designer Metallic Upgrade	<ul style="list-style-type: none"> <li>• Smooth faced Oil Rubbed Bronze head, bottom rails and end caps</li> <li>• Smooth faced Brushed Nickel head, bottom rails and end caps</li> </ul>

Mounting Dimensions	Simplicity Motorized Hardware System
Minimum Shallow Mount	1/2"
Minimum Flush Inside Mount	2 1/4"
Minimum Outside Mount	7/8"
Minimum Side Mount	1 1/4"
Minimum Flush Side Mount	2 1/4"
<b>Recommended Side Mounting Method</b>	<ul style="list-style-type: none"> <li>• See page 50 for recommended mounting method for side mount shades</li> <li>• Width limit for side mount brackets is 48"</li> </ul>

Finished Dimensions	
Inside Mount	
	<ul style="list-style-type: none"> <li>• Fabric will measure ordered width less: 3/8"</li> <li>• Head rail* will measure ordered width less: 3/16"</li> </ul>
Outside Mount	
	<ul style="list-style-type: none"> <li>• Fabric will measure ordered width</li> <li>• Head rail* will measure ordered width plus: 3/16"</li> </ul>
Side Mount	
	<ul style="list-style-type: none"> <li>• Fabric will measure ordered width less: 7/8"</li> <li>• Head rail* will measure ordered width less: 1 1/16"</li> </ul>
Exact (End Cap to End Cap) Mount	
	<ul style="list-style-type: none"> <li>• Fabric will measure ordered width less: 3/16"</li> <li>• Head rail* will measure ordered width</li> </ul>

\* Head rail measurements include endcaps. Width and length measurements may vary +/- 1/8"

CELLULAR HARDWARE

# Cellular Shade Collection

## POWERTOCH RECHARGEABLE MOTORIZED HARDWARE SYSTEM

### PowerTouch™ Rechargeable Shades

Cellular Shades can be fabricated with the PowerTouch Rechargeable Push Button Control option. The PowerTouch Rechargeable option is an easy, cord free motorized operation for the budget savvy homeowner. PowerTouch Rechargeable uses Simplicity motors and components.

### PowerTouch Rechargeable Shades Operation

Press the up or down button on the pendant to raise or lower the shading to your desired position.

No programming is required with PowerTouch™, all programming is set at the factory. Upper and lower limits can easily be adjusted in the field if desired. Please refer to the installation instructions at [comfortex.com/comfortex-dealers](http://comfortex.com/comfortex-dealers). A "favorites" or intermediate stop position can be set once installed.

### PowerTouch Rechargeable Surcharges

See page 10.

### PowerTouch Appearance

- The PowerTouch wand and pendant is attached to the head rail when installed.
- The wand and pendant hangs down the front of the shades from the head rail. The wand does not touch the fabric.
- Pendant is 2½" long.
- The pendant does not need to be mounted to the wall to operate the shade.



### PowerTouch Rechargeable Color Options

- Shades with Black or Oil Rubbed Bronze hardware will be built with black wand and pendants standard. All other colors will use white wand and pendants.



White



Black Shown with Plug-In Charger

### PowerTouch Wand and Pendant Location

The standard location for the wand and pendant is on the right. Please specify location when ordering.

### PowerTouch Rechargeable Wand Length

- The standard length of the wand will measure the indicated below unless otherwise specified.

Shading Length	Standard Wand Length
Up to 30"	1' (12")
>30" to 52"	2' (24")
>52" to 78"	3' (36")
>78" to 100"	4' (48")
>100" to 120"	5' (60")

### Mounting Requirements for PowerTouch Rechargeable Shades

- No special installation hardware or wiring requirements are needed.

### Battery Charger

8.4 Volt charger requires a standard power outlet to recharge the battery wand. Must specify charger when ordering a Simplicity Rechargeable Wand Shade. The charger plugs into the charger port. The charger is black and comes with a 156" wire. The dimensions are 1" wide x 2½" length x 1¾" deep.



### PowerTouch Rechargeable Shades Warranty

Please see page 128 for complete warranty information.

CELLULAR HARDWARE

Cellular Shade Collection

OVATION CELLULAR SLIDER HARDWARE SYSTEM

Prelude Hardware Page 105

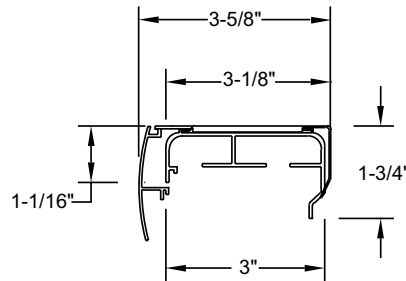

**Ovation Hardware Rail Dimensions**

- Depth of rail: 3"
- Depth of rail and bracket: 3 1/8"
- Depth of rail, bracket & valance: 3 5/8"
- Height: 1 3/4"

CELLULAR HARDWARE

Hardware Features	
Standard Hardware Color	Aspen White #785
Optional Hardware Colors	Ivory, beige, tan and gray rails are available as an option. Visit <a href="http://comfortex.com">comfortex.com</a> to view color options <ul style="list-style-type: none"> <li>• Silverado #276</li> <li>• Honey Bisque #882</li> <li>• Camel #082</li> <li>• Gardenia White #862</li> </ul>

Mounting Dimensions	Ovation Hardware System
Minimum Inside Mount	3/4"
Minimum Flush Mount	3 5/8"
Minimum Outside Mount	5/8"

**Finished Dimensions**

Inside Flush Mount	
Track Width:	
Right or Left Stack	3/16" less than ordered width
Split Stack	3/16" less than ordered width
Center Stack	3/16" less than ordered width
Finished Slider Length	1/2" less than ordered length
Valance	3/16" less than ordered width
Outside Mount	
Track Width	Ordered width
Finished Slider Length	Ordered length - No reductions will be made
Valance	Ordered width plus 1 1/4"
Valance Returns	Will measure 3 1/8" (standard)



# Cellular Shade Collection

## OVATION CELLULAR SLIDER HARDWARE SYSTEM

Prelude Hardware Page 105

### Applications

- Standard Rectangular
- Opens and closes from side to side
- Four stacking options - see below.
- Dual Panel option with a center opening design with two fabrics, one on each side, each spanning the width of the window.

### Ovation Stacking Options

Specify stacking configuration when ordering.

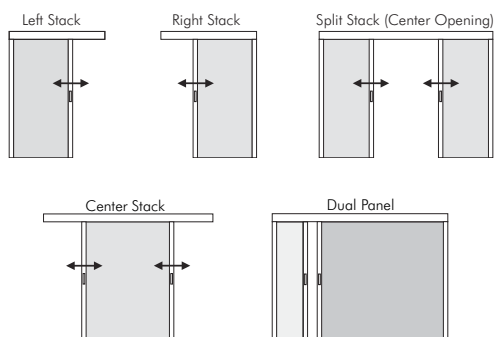

**Left:** Fabric stacks to the left side of the slider.

**Right:** Fabric stacks to the right side of the slider.

**Center Stack:** Center Stack Sliders fabric panels can move fully to the left or the right.

**Split Stack:** Fabric is split in the center of the slider forming two equal panels which open to opposite ends of the slider. Both panels will be of equal width unless otherwise specified. Split stack is not available with Gradient shades.

\* Split stack sliders are available in maximum widths from 240" to 336" (maximum width depends on the fabric selected). If the width exceeds the maximum width of the fabric, it will be fabricated as two separate sliders. The supplied valance will create the appearance of a single slider. Call Customer Service for assistance.

**Dual Panel:** A Dual Panel Stack Slider has a center opening design with a different fabric on each side, each of which can span the full width of the window. Both panels will be of equal width unless otherwise specified. Specify which fabric stacks to left and which fabric stacks to the right.

### Ordering Information for Ovation Cellular Sliders

- Specify IB or OB mount.
- Specify stacking configuration.
  - On Dual Panel Shades, specify which fabric stacks to the left and right.
  - On Split Stack Shades, both panels will be of equal width unless specified.
- Specify valance width and return length.

### Ovation Valance Specifications

- Every Ovation Slider is supplied with a painted aluminum valance to match your hardware color choice.
- The valance attaches to the head rail using a durable plastic clip system.

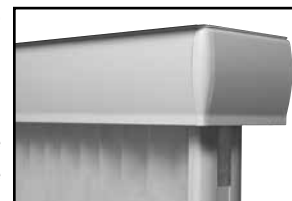

### Ovation Valance Dimensions

All valance dimensions are measured on the flat, back side.

- Valance Height: 2<sup>3</sup>/<sub>4</sub>"
- Standard Return Length (OB only): 3<sup>1</sup>/<sub>8</sub>"
- For each spacer block, 1/2" will be added to the length of the valance returns. For extension brackets, 2" will be added unless otherwise instructed.
- If the slider requires a non-flush inside mount, you must order a custom valance. Exact valance width and exact valance return length (minimum 1 1/2") must be specified in the Special Instructions section of the order form.
- Custom returns are available for IB non-flush and OB Cellular Sliders. Please specify return length upon ordering.

### Things to Consider

- Since most Ovations are sold in large sizes, the shade will have a large fabric stack. On an outside mount, you may want to order the shade a few inches wider so that the fabric stack can be clear of the window. For more information on Ovation's stack height, see pages 8-9 for information.
- Premiere Custom Design fabrics will be turned 90 degrees on Ovation Shades. The pattern orientation will be left to right since Ovation shades open side to side. Split stack is not available with Gradient shades.
- Symphony double honeycomb fabric may require additional care when opening or closing the shade. Double honeycomb fabric is generally stiffer than single honeycomb material and may offer minor resistance when opening and closing. If this is a concern, Comfortex recommends selecting a coordinating fabric from the Virtuoso or Baritone collections.

CELLULAR HARDWARE

# The Ultimate Blackout Cellular Shade

## INSULATING SLUMBERSHADES HARDWARE SYSTEM



### Standard Head Rail

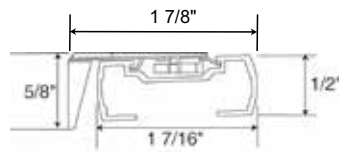

### Deluxe Head Rail

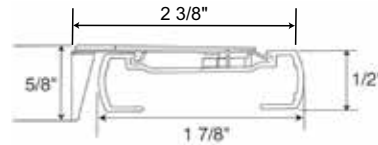

### Cord Loop, Cordless Ultra & Motorized Head Rail (Standard & Top Down-Bottom Up)

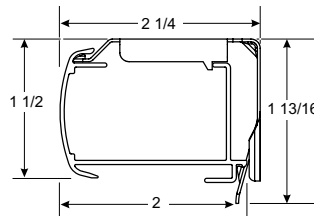

### Standard Cord Lock Rail

- Depth of rail: 1 7/16"
- Depth of rail and bracket: 1 7/8"
- Height of rail: 1/2"
- Height of bracket: 5/8"

### Deluxe Cord Lock Rail

- Depth of rail: 1 7/8"
- Depth of rail and bracket: 2 3/8"
- Height: 1/2"
- Height of bracket: 5/8"

### Cord Loop & Cordless Ultra Rail

- Depth of rail: 2"
- Depth of rail and bracket: 2 1/4"
- Height of rail: 1 1/2"
- Height of bracket: 1 13/16"

CELLULAR HARDWARE

Hardware Features	
Hardware colors for all Cellular fabrics	Color coordinated head, middle, bottom rails and end caps
Blackout Sidetrack Colors Available	White, Tan and Bronze

Upgrades	
Fabric Wrapped Upgrade	Fabric used is same fabric as the shade. Back of rail is white to outside.
Designer Metallic Upgrade	• Oil Rubbed Bronze and Brushed Nickel head, middle, bottom rails and end caps.

Mounting Dimensions (inside mount only)	Standard Head Rail	Deluxe Head Rail
<b>Standard Cord Lock (Standard Rectangular and Top Down-Bottom Up)</b>		
Minimum Inside Mount	1 1/2"	1 1/2"
Minimum Flush Inside Mount	2"	2 3/8"
<b>Cord Loop &amp; Cordless Ultra (Standard Rectangular and Top Down-Bottom Up)</b>		
Minimum Inside Mount	1 5/8"	NA
Minimum Flush Inside Mount	2 1/4"	NA

**Outside, shallow and side mounts are not available.** The shade's light blocking ability is compromised by using any other mount than a fully flush mount application.

Finished Dimensions	
<b>Inside Mount</b>	
	<ul style="list-style-type: none"> <li>• Fabric will measure ordered width less: 7/8"</li> <li>• Head rail and bottom rail will measure ordered width less: 1 1/16"</li> <li>• Sidetrack length will measure ordered length less: 1/8"</li> </ul>

The widest width of the window cannot exceed the narrowest width of the window by more than 1/4". **Precise width measurements are critical to proper performance of SlumberShade products.** Make sure to measure to the nearest 1/16" and provide the **NARROWEST** width measurement along the length of the window. Be sure to measure the top, middle and bottom of the opening. It is very common for the width of a window to vary from top to bottom.

# The Ultimate Blackout Cellular Shade

## INSULATING SLUMBERSHADES HARDWARE SYSTEM

### Insulating SlumberShades Small Track Dimensions Used with all fabrics standard size head rail.

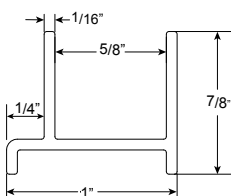

#### Small Track

- Width of track: 1"
- Height of track: 7/8"

### Insulating SlumberShades Large Track Dimensions Used with all fabrics that utilize the deluxe sized head rail.

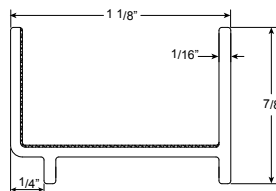

#### Large Track

- Width of track: 1 1/8"
- Height of track: 7/8"

### Applications

- Standard Rectangular
- Top Down - Bottom Up
- Cordless and Cordless Top Down - Bottom Up
- Cord Loop and Top Down - Bottom Up
- Motorization

SlumberShades are for inside mount applications only.

### Insulating SlumberShade Fabric

Light Filtering fabrics are available as SlumberShades, however the best light control is achieved by using a blackout cellular fabric.

### Ordering Information for Insulating SlumberShades

SlumberShades are for inside mount applications only.

**Precise width measurements are critical to proper performance of SlumberShade products.** Make sure to measure to the nearest 1/16" and provide the **NARROWEST** width measurement along the length of the window. Be sure to measure the top, middle and bottom of the opening. It is very common for the width of a window to vary from top to bottom. The widest width of the window cannot exceed the narrowest width of the window by more than 1/4". If you have questions about ordering SlumberShades, contact Comfortex Technical Services at 800-843-4151.

### Accessories

- 6' Expandable
- 12' Expandable

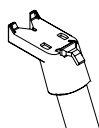

Specially designed pole end fits into the handle on the Cordless Ultra bottom rail and allows for easy operation.

### Insulating SlumberShades Features

Use SlumberShades to provide the darkest sleeping environment by sealing out all the light

### Energy Saving Blackout Sidetracks

Energy saving blackout sidetracks are made from a durable window grade PVC. The blackout sidetracks seal off the light gap between the blackout cellular shade and the window. The blackout sidetracks feature a black interior lining to absorb light and prevent it from entering the room.



### Motorization Options

Learn about the motorization options on pages 55-59.

SlumberShades are easy to install, and feature removable sidetracks that are attached to the window frame with magnets. The sidetracks can be removed for window cleaning. The UV stable, window grade PVC sidetracks are available in white, tan and bronze to match your existing trim.

**Please Note:** When properly installed, SlumberShades block 99% of all visible light. In certain installations with intense sunlight, a very small amount of light may reflect around the edges of the honeycomb fabric along each side of the shade. This is a normal attribute of the SlumberShade system.

### Insulating SlumberShade End Caps

The specially designed notched bottom rail end caps fit over the blackout sidetracks and allow for smooth movement when raising and lowering the shade.

### Head and Bottom Rail Seals

To ensure a perfectly dark sleeping environment, additional fuzz seals are supplied to be placed along the shade's bottom rail and between the head rail and the window frame if needed. These barriers provide a complete light stop all the way around the window to keep all exterior light out. Also, these additional seals provide a very effective barrier against heat loss along your windows.

Magnets and fuzz bar are standard on Cordless and Cordless Top Down-Bottom Up Shades to ensure closure between the bottom rail and window sill.

### Energy Efficiency

Independent testing has shown SlumberShades provide an R-value greater than 7.0\* when installed over a double paned vinyl window. The testing also indicates that the R-value of a SlumberShade is 2.5 to 3 times higher than that of the same shade without sidetracks. The insulating cellular fabric, sidetracks, and fuzzy seal all ensure that the SlumberShades provides superior energy efficiency.

\* Independent testing provided by Consortium for Advanced Residential Buildings (CARB), a U.S. Department of Energy Building America research team. Learn more at [comfortex.com/comfortex-dealers](http://comfortex.com/comfortex-dealers).

### EZ Level

Learn about the EZ Level feature on page 122.

CELLULAR HARDWARE

# Cellular Specialty Shades

## STARBURST ARCHES HARDWARE SYSTEM

Prelude Hardware Page 105

### Stationary Starburst

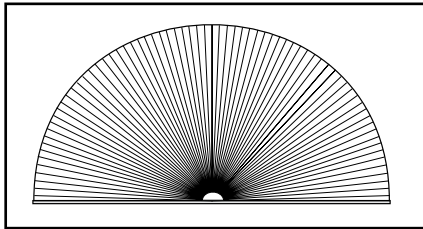

Figure A

### Movable Starburst

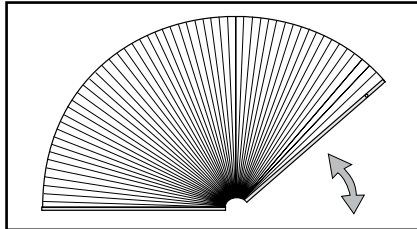

Figure B

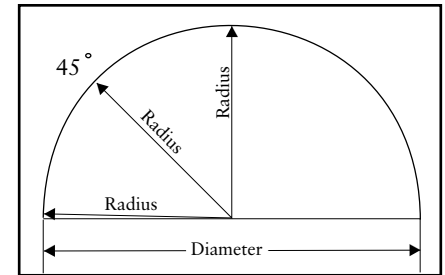

Figure C

Hardware Features   See Page 47 for Rail Dimensions	
Hardware colors	Color coordinated rails
Upgrades	
Fabric Wrapped Upgrade	Fabric used is same fabric as the shade. Back of rail is white to outside. Color coordinated end caps. <b>Please note:</b> On Stationary Starburst Arches the fabric wrap will be spliced in the center of the base rail.
Designer Metallic Upgrade	<ul style="list-style-type: none"> <li>• Oil Rubbed Bronze rails with bronze colored end caps.</li> <li>• Brushed Nickel rails and end caps.</li> </ul>
Mounting Dimensions	
	<b>Standard Cord Lock Rail</b>
	<b>Deluxe Cord Lock Rail</b>
Minimum Shallow Mount	3/4"
Minimum Flush Inside Mount	2"
Minimum Flush Outside Mount	2 3/8"
Recommended Side Mounting Method	
	<ul style="list-style-type: none"> <li>• See page 48 figure B for recommended mounting method for side mount shades</li> <li>• Width limit for side mount brackets is 48"</li> </ul>
Finished Dimensions	
Inside and Side Mount	
<ul style="list-style-type: none"> <li>• Fabric will measure ordered width less: 3/8"</li> <li>• Head rail* will measure ordered width less: 3/16"</li> </ul>	<ul style="list-style-type: none"> <li>* Head rail measurements include endcaps.</li> <li>Width and length measurements may vary +/- 1/8"</li> </ul>

CELLULAR HARDWARE

### Applications

- Stationary Fan Style Arch
  - Movable Fan Style Arch
- Movable Starburst Arch shades are for inside and shallow mount applications only.

### Stationary Starburst Features (Figure A)

- **All non-perfect Stationary Starburst arches require a template made from brown craft paper.** Comfortex offers template kits. Please contact Customer Service to order. Stock number: 751000, See page 127
- A perfect arch is twice as wide as it is high.
- Stationary Starburst shades which are not perfect half circles must have a height that equals half the width +/- 5".
- Price according to the largest radius measurement. If the height is greater than the width, take height X 2 and use that number to determine pricing.
- When ordering arches as perfect half-circles make sure the radius of the arch remains constant to ensure a proper fit. (See Figure C)

### Movable Starburst Features (Figure B)

- Starburst Movable archtop shades are cut to perfect half circles only and do not require a template. The height must be exactly 1/2 the diameter.
- A perfect arch is twice as wide as it is high.
- When ordering arches as perfect half circles make sure the radius of the arch remains constant to ensure a proper fit. (See Figure C)
- The hinge gap (gap between the two rails) is not centered in the window. The moving rail is always smaller than the stationary rail to provide proper movement within the window.

### Accessories

- 6' Expandable Pole
- 12' Expandable Pole



Specially designed pole end fits into the handle on movable Starburst Shades for easy operation.

# Cellular Specialty Shades

## SUNSET ARCHES HARDWARE SYSTEM

Prelude Hardware Page 105

Movable Sunset

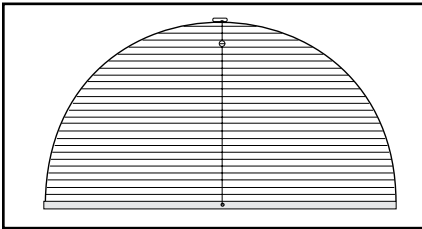

Figure A

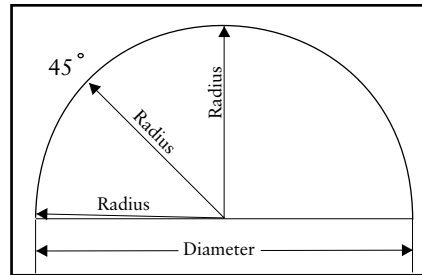

Figure B

Two-String Hanging Method

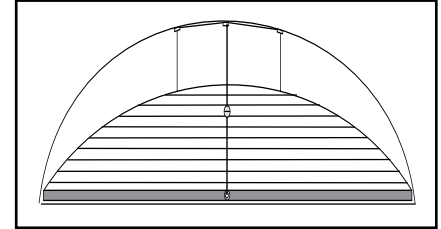

Figure C

CELLULAR HARDWARE

### Hardware Features | See Page 47 for Rail Dimensions

Hardware colors for all Cellular fabrics	Color coordinated rails with white cord and silver tassel
--	---

### Upgrades

Fabric Wrapped Upgrade	Fabric used is same fabric as the shade. Back of rail is white to outside. Color coordinated end caps.
Designer Metallic Upgrade	<ul style="list-style-type: none"> <li>• Oil Rubbed Bronze rails with bronze end caps, white cord and silver tassel.</li> <li>• Brushed Nickel rails and end caps with silver tassel and white cord.</li> </ul>

### Mounting Dimensions

	Standard Cord Lock Rail	Deluxe Cord Lock Rail
Minimum Shallow Mount	3/4"	3/4"
Minimum Flush Inside Mount	2"	2 3/8"
Minimum Outside Mount	3/4"	3/4"
Minimum Side Mount	1 1/8"	1 3/8"
Minimum Flush Side Mount	1 5/8"	1 7/8"

<b>Recommended Side Mounting Method</b>	<ul style="list-style-type: none"> <li>• See page 48 figure B for recommended mounting method for side mount shades</li> <li>• Width limit for side mount brackets is 48"</li> </ul>
---	--

### Finished Dimensions

#### Inside and Side Mount

	<ul style="list-style-type: none"> <li>• Fabric will measure ordered width less: 3/8"</li> <li>• Head rail* will measure ordered width less: 3/16"</li> </ul>
--	---

#### Outside Mount

	<ul style="list-style-type: none"> <li>• Fabric will measure ordered width</li> <li>• Head rail* will measure ordered width plus: 3/16"</li> </ul>
--	--

#### Exact (End Cap to End Cap) Mount

	<ul style="list-style-type: none"> <li>• Fabric will measure ordered width less: 3/16"</li> <li>• Head rail* will measure ordered width</li> </ul>
--	--

\* Head rail measurements include endcaps.  
Width and length measurements may vary +/- 1/8"

### Applications

- Movable Arch

### Ordering Information for Sunset Shades

- Specify IB or OB mount and rail color.
- Include a template if the shade is wider than 58".

### Accessories

- 6' Expandable Pole
- 12' Expandable Pole



Specially designed pole end fits into the ball on Sunset Shades for easy operation.

# Cellular Specialty Shades

## SUNSET ARCHES HARDWARE SYSTEM

Prelude Hardware Page 105

### Sunset Features and Ordering Notes (Figure A)

- Sunset shades have horizontal pleats that stack at the bottom, on a stationary sill rail. Sunset shades are operated by a continuous cord that runs through a top mount guide block and back down through the stationary rail. A moving metal ball attached to the cord is used to raise and lower the shade. (See Figure E).
- **All Sunset arches which are not perfect half circles require a template if shade is wider than 58".** A perfect arch is twice as wide as it is high. See page 125 for template instructions.
- **All templates should be made from brown craft paper.** Comfortex offers template kits. Please contact Customer Service to order. Stock number: 751000
- Sunset shades which are not perfect half circles must have a height which is equal to or greater than 25% of the width.
- When ordering Sunset shades that are perfect half circles, make sure the radius of the arch remains constant to ensure a proper fit. (See Figure B) on page 72.
- **Size Limitations:** Though our maximum width is 84" and our maximum length is 72", there are limitations on some larger sizes due to excessive weight. If the Sunset width exceeds 66", the maximum length is 60". If the Sunset width exceeds 72", the maximum length is 48".
- **Stringing Method:** Depending on the curvature of a particular arch, it may be necessary to use the two string method to ensure proper fit and operation of your Sunset shade. Comfortex will determine the best stringing method after examination of the template.
- **For Symphony (All), Premiere 1/2" Fabrics, and Debut 1/2" single:** If Sunset shades exceed 65" in width or 50" in length, two pieces of mono filament cord are included to help stabilize the shade once installed.
- **For Debut 1/2" double, Debut 3/4" Fabrics and Linen Weave fabrics:** If Sunset shades exceed 45" in width or in length, two pieces of mono filament cord are included to help stabilize the shade once installed.
- **Arch Styles:** Sunset arches are available in a variety of styles including: palladium, eyebrow and bullet shaped arches. (See Figure D).

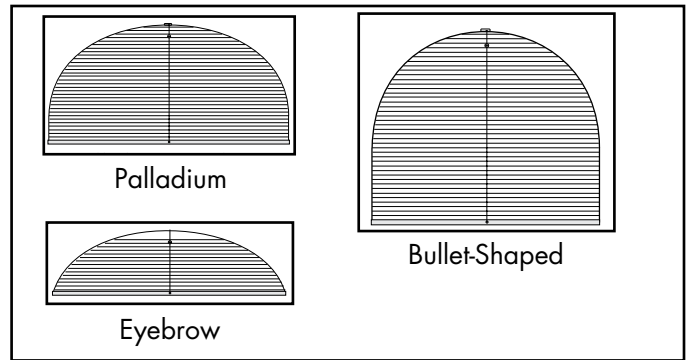

Figure D

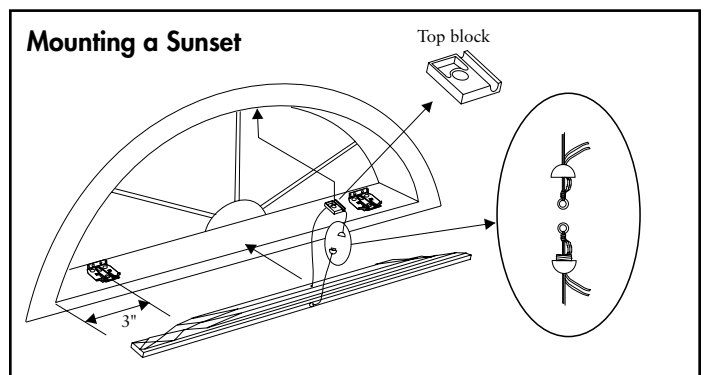

Figure E

### Recommended Mounting Method for Side Mounting Shades

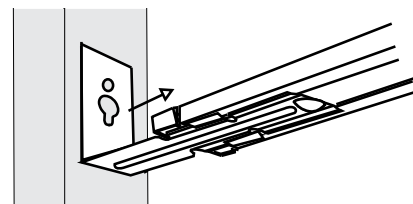

Figure F

Refer to the installation instructions on [Comfortex.com/comfortex-dealers](http://Comfortex.com/comfortex-dealers) or the OnDemand Mobile Library for further details on side mounting shades.

# Cellular Specialty Shades

## QUARTER ROUNDS HARDWARE SYSTEM

Prelude Hardware Page 110

### Movable Quarter Round

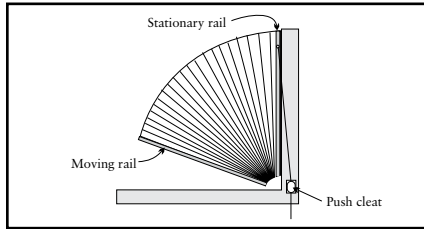

Figure A

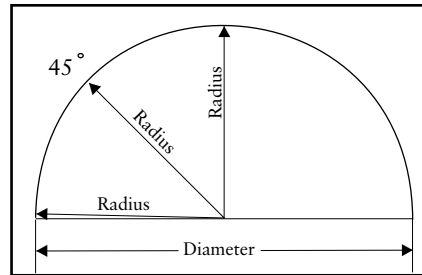

Figure B

### Stationary Quarter Round

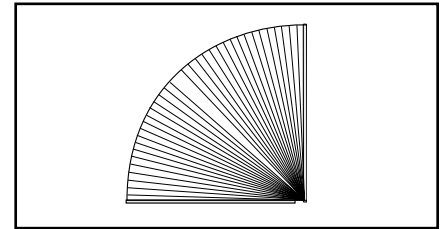

Figure C

CELLULAR HARDWARE

### Hardware Features | See Page 47 for Rail Dimensions

Hardware colors for all Cellular fabrics	Color coordinated rails with white cord and tassel
--	--

### Upgrades

Fabric Wrapped Upgrade	Fabric used is same fabric as the shade. Back of rail is white to outside. Color coordinated end caps.
Designer Metallic Upgrade	<ul style="list-style-type: none"> <li>• Oil Rubbed Bronze rails and endcaps, bronze colored tassel and white cord.</li> <li>• Brushed Nickel rails and end caps with coordinating tassel and white cord.</li> </ul>

Mounting Dimensions	Standard Rail	Deluxe Rail
Minimum Shallow Mount	3/4"	3/4"
Minimum Flush Inside Mount	2"	2 3/8"
Minimum Outside Mount	3/4"	3/4"
Minimum Side Mount	1 1/8"	1 3/8"
Minimum Flush Side Mount	1 5/8"	1 7/8"
<b>Recommended Side Mounting Method</b>	• See page 73 figure F for recommended mounting method for side mount shades	

### Finished Dimensions

Inside and Side Mount	
	<ul style="list-style-type: none"> <li>• Fabric will measure ordered width less: 3/8"</li> <li>• Head rail* will measure ordered width less: 3/16"</li> </ul>
Outside Mount	
	<ul style="list-style-type: none"> <li>• Fabric will measure ordered width</li> <li>• Head rail* will measure ordered width plus: 3/16"</li> </ul>
Exact (End Cap to End Cap) Mount	
	<ul style="list-style-type: none"> <li>• Fabric will measure ordered width less: 3/16"</li> <li>• Head rail* will measure ordered width</li> </ul>

\* Head rail measurements include endcaps.  
Width and length measurements may vary +/- 1/8"

### Applications

- Stationary Fan Style Quarter Round
- Movable Fan Style Quarter Round

### Accessories

- 6' Expandable Pole
- 12' Expandable Pole



### Ordering Information for Quarter Rounds Shades

- Specify IB or OB mount and rail color.
- Include a template if the shade is a non-perfect quarter round.

Specially designed pole end fits into the handle on movable Quarter Round Shades for easy operation.

# Cellular Specialty Shades

## QUARTER ROUNDS HARDWARE SYSTEM

Prelude Hardware Page 110

### Quarter Rounds Features (Figure A) pg 74

- **All Quarter Round Shades which are not perfect quarter circles require a template.** Price according to the largest radius measurement.
- See page 125 for template instructions.
- **All templates should be made from brown craft paper.** Comfortex offers template kits. Please contact Customer Service to order. Stock number: 751000
- The horizontal (moving) rail of a Movable Quarter Round shade **must be smaller** than the vertical (stationary) rail to allow clearance for the moving rail. The shade will stack in the vertical position.
- When ordering arches as perfect quarter circles, make sure the radius of the arch remains constant to ensure a proper fit. (See Figure B) pg 74



CELLULAR HARDWARE

### Operation

#### Moveable Quarter Round

Pull the cord down to bring the shade to a stacked position.

The shade stacks against the vertical rail.

Push the button in on the cord cleat to release the cord and lower the shade across the window.

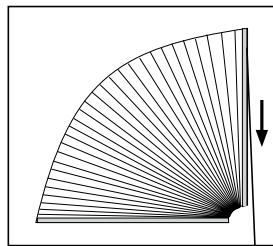

**WARNING:** To avoid possible strangulation, keep cords out of reach of children.



# Cellular Specialty Shades

## TRAPEZOIDS AND OCTAGONS HARDWARE SYSTEM

Prelude Hardware Page 111

### Movable Trapezoids

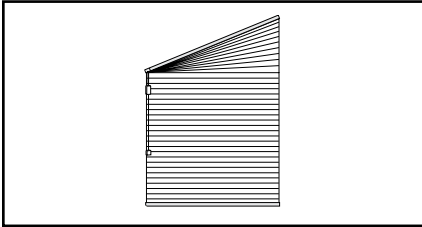

### Movable Octagons

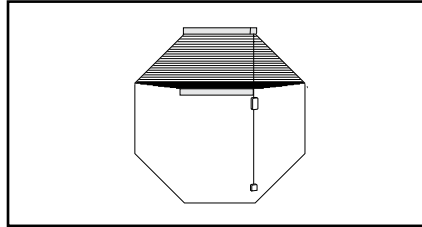

CELLULAR HARDWARE

Hardware Features   See Page 47 for Rail Dimensions		
Hardware colors for all Cellular fabrics	Color coordinated head and bottom rails with white cord and tassel	
Upgrades		
Fabric Wrapped Upgrade	Fabric used is same fabric as the shade. Back of rail is white to outside. Color coordinated end caps.	
Designer Metallic Upgrade	<ul style="list-style-type: none"> <li>• Oil Rubbed Bronze head and bottom rails with bronze colored tassel, end caps and white cord.</li> <li>• Brushed Nickel head and bottom rails and end caps with coordinating tassel and white cord.</li> </ul>	
Mounting Dimensions	Standard Cord Lock Rail	Deluxe Cord Lock Rail
Minimum Shallow Mount	3/4"	3/4"
Minimum Flush Inside Mount	2"	2 3/8"
Minimum Outside Mount	3/4"	3/4"
Minimum Side Mount	1 1/8"	1 3/8"
Minimum Flush Side Mount	1 5/8"	1 7/8"
Recommended Side Mounting Method	• See page 73 for recommended mounting method for side mount shades	
Finished Dimensions		
Inside and Side Mount		
	<ul style="list-style-type: none"> <li>• Fabric will measure ordered width less: 3/8"</li> <li>• Head rail* will measure ordered width less: 3/16"</li> </ul>	
Outside Mount		
	<ul style="list-style-type: none"> <li>• Fabric will measure ordered width</li> <li>• Head rail* will measure ordered width plus: 3/16"</li> </ul>	
Exact (End Cap to End Cap) Mount		
	<ul style="list-style-type: none"> <li>• Fabric will measure ordered width less: 3/16"</li> <li>• Head rail* will measure ordered width</li> </ul>	
* Head rail measurements include endcaps. Width and length measurements may vary +/- 1/8"		

### Applications

- Movable Trapezoids
- Movable Octagons

### Ordering Information for Trapezoid Shades

- Specify IB or OB mount and rail color.
- **Trapezoid orders must be faxed or emailed in with a diagram. Please provide measurements for all four sides when ordering. No template is required.**

### Ordering Information for Octagon Shades

- Specify IB or OB mount and rail color.
- **Octagon Shades do not require a template. The width, length and one side are required measurements when ordering.**

# Cellular Specialty Shades TRAPEZOIDS AND OCTAGONS HARDWARE SYSTEM

Prelude Hardware Page 111

## Trapezoids (Figure A)

- Trapezoid orders must be faxed in with a diagram. Please provide measurements for all four sides when ordering. No template is required.
- The maximum slope of the top rail is 30 degrees from horizontal. Slope is the angle between slope and a horizontal line. The slope angle must be measured with a protractor.
- Sides of trapezoid must be parallel.
- Sill must be level for proper installation and operation of a trapezoid shade.
- Operating cord must be placed on the short side.
- See Figures B and C for trapezoid shade operation.

## Octagons

- Octagon Shades do not require a template.
- The width, length and one side are required measurements when ordering.
- Octagon shades raise only to the point where the top angle begins. (See Figure D)
- See Figure F on page 73 for recommend mounting method for side mount shades.

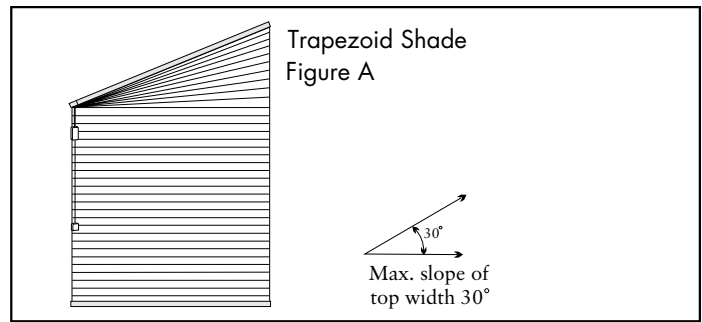

## Trapezoid Shade Operation

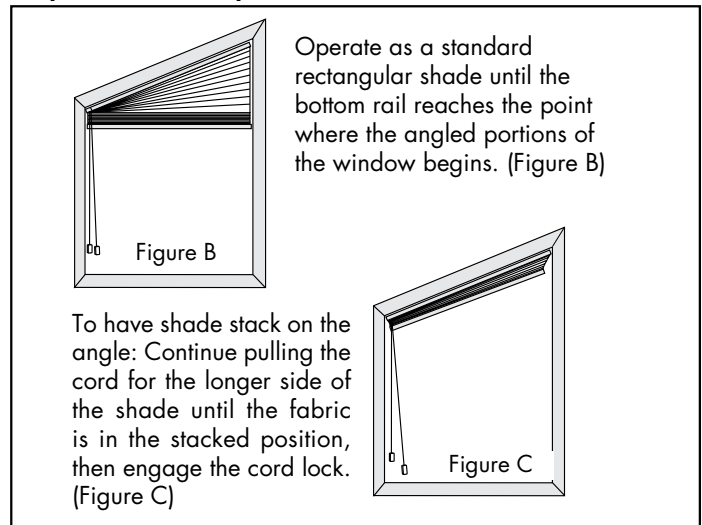

## Octagon Operation

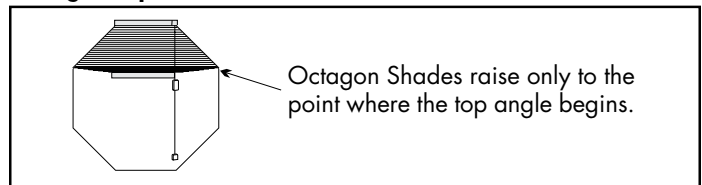

Figure D



CELLULAR HARDWARE

# Cellular Specialty Shades

## SOPRANO SKYLIGHTS AND GREENHOUSE SHADES HARDWARE SYSTEM

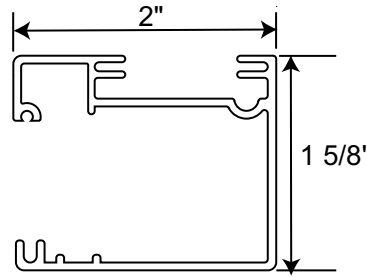

### Soprano Rail Dimensions

- Depth of rail: 2"
- Height of rail: 1 5/8"

CELLULAR HARDWARE

Hardware Features	
Hardware colors	<ul style="list-style-type: none"> <li>• White head, bottom rail with white gear track retainer.</li> <li>• Bronze head, bottom rail with bronze gear track retainer.</li> </ul>
Mounting Dimensions	Soprano Skylights and Greenhouse Shades
Minimum depth required for installation	1 1/2"
Minimum Flush Inside Mount (Rail Fully Recessed)	2 3/8"
Minimum Flush Inside Mount (Handle Fully Recessed)	3"
Deductions	
	Total deduction on the bottom moving rail is 3 1/4"
	Total deduction on the top rail is 1 1/2"
Finished Dimensions	
Inside Mount	
	<ul style="list-style-type: none"> <li>• Fabric will measure ordered width less: 3/8"</li> <li>• Head rail* will measure ordered width less: 3/16"</li> </ul>
* Head rail measurements include endcaps. Width and length measurements may vary +/- 1/8"	

### Applications

- Soprano Skylights
- Soprano Greenhouses

Soprano Shades are for inside mount applications only.

### Ordering Information for Soprano Skylights and Greenhouse Shades

- Specify White or Bronze Rails.
- For Greenhouse Shades, supply measurements for: straight top section, curved section and vertical straight section when ordering.

### Accessories

- Two Moving Rails\*
- 6' Expandable Pole
- 12' Expandable Pole

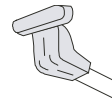

Specially designed pole end fits into the handle of Soprano shades for easy operation at any angle.

\*This option allows you to move shade up from the bottom or down from the top. For ultimate control of light and privacy. See page 10 for upgrade pricing.

### Skylight Installation Angles

- For inside mount applications on straight (planar) runs.
- Minimum Installation angle of 5 degrees.
- Maximum installation angle of 85 degrees.
- Horizontal (0 degrees) and vertical (90 degrees) applications are not recommended.

# Cellular Specialty Shades

## SOPRANO SKYLIGHTS AND GREENHOUSE SHADES HARDWARE SYSTEM

### Soprano Skylight Features (Figure A)

- Soprano Shades feature a polycarbonate track system. The hidden gear track allows for smooth operation of the shade and controls light.
- The gear track retainer is White or Bronze to match the moving bottom rail. **Please specify rail color when ordering.**

### Soprano Greenhouse Shades Features (Figure B)

- See Figure C below for Greenhouse shade ordering information.
- Soprano Shades are for inside mount applications only.
- **All greenhouse orders require a completed and signed greenhouse shade order form.** Orders must be mailed or faxed to Comfortex for processing. Download a copy at [www.comfortex.com/comfortex-dealers](http://www.comfortex.com/comfortex-dealers) or from the OnDemand Library Mobile Library.
- Soprano Shades feature a polycarbonate track system. The hidden gear track allows for smooth operation of the shade and controls light.
- The gear track retainer is White or Bronze to match the moving bottom rail. **Please specify rail color when ordering.**

### Soprano Skylights

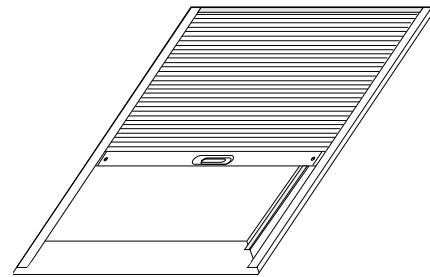

Figure A

### Soprano Greenhouses

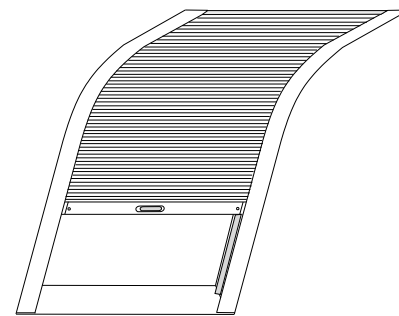
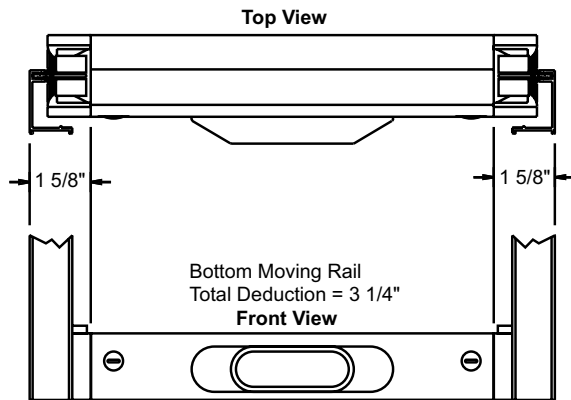
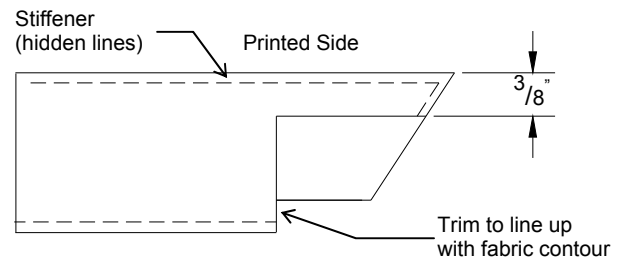

Figure B



Soprano Skylights and Greenhouses Moving Rail  
Top and Front View

### Soprano Fabric Notch for small pleat fabric



Additional trimming for bottom stiffener (and attached single layer of fabric).

### Greenhouse Ordering Information Figure C

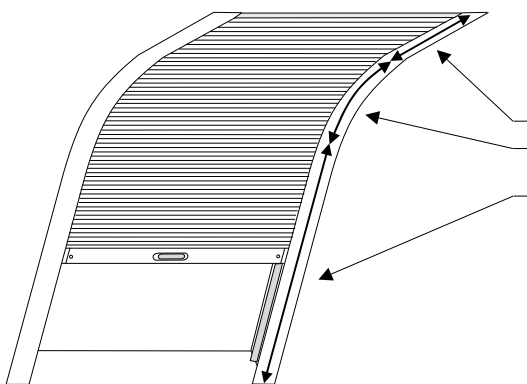

The side rails for greenhouse shades are notched at the curve in the factory. Please supply measurements for:  
 Straight top section,  
 Curved section and  
 Vertical straight section when ordering.

CELLULAR HARDWARE

# Cellular Specialty Shades

## BALCONY SHADING HARDWARE SYSTEM

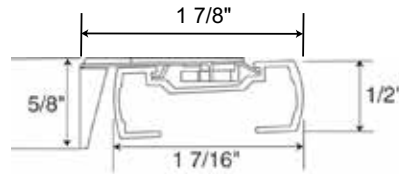
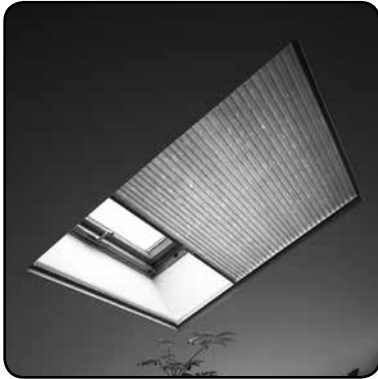

### Balcony Rail Dimensions

- Depth of rail: 1 7/16"
- Depth of rail and bracket: 1 7/8"
- Height of rail: 1/2"

CELLULAR HARDWARE

Hardware Features	
Hardware colors for all fabrics	Color coordinated head and bottom rails with white cord in a white sidetrack.
Upgrades	
Fabric Wrapped Upgrade	Fabric wrapped head and bottom rails. Fabric used is same fabric as the shade. Back of rail is white to outside.
Designer Metallic Upgrade	<ul style="list-style-type: none"> <li>• Designer Oil Rubbed Bronze head and bottom rails with white cord in a white sidetrack.</li> <li>• Designer Brushed Nickel head and bottom rails with white cord in a white sidetrack.</li> </ul>

Mounting Dimensions - Inside Only	Balcony Shading System
Minimum required for installation	1 1/4"
Minimum Flush Inside Mount (Rail Fully Recessed)	2 1/4"
Minimum Flush Inside Mount (Handle Fully Recessed)	2 1 1/16"

The widest width of the window cannot exceed the narrowest width of the window by more than 3/8".

Finished Dimensions	
Inside Mount	
	<ul style="list-style-type: none"> <li>• Fabric will measure ordered width less: 3/8"</li> <li>• Head rail* will measure ordered width less: 3/16"</li> </ul>
* Head rail measurements include endcaps. Width and length measurements may vary +/- 1/8"	

### Applications

- Horizontal, Angled and Vertical rectangular windows and skylights. Balcony Shading Systems are for inside mount applications only.

### Ordering Information for Balcony Shading System

- Specify rail color.
- Specify when ordering: Application angle: Angled, Horizontal or Vertical.

### Accessories

- 6' Expandable Pole
- 12' Expandable Pole



Specially designed pole end fits into the handle of Balcony shades for easy operation at any angle.

# Cellular Specialty Shades

## BALCONY SHADING HARDWARE SYSTEM

### Balcony Shading System Features

- Balcony Shades work in three orientations applications: Angled, Horizontal and Vertical.  
Horizontal works on slope angles 0 to 15 degrees.  
Angled works on slope angles 15 to 75 degrees.  
Vertical works on slope angles 75 to 90 degrees.
- Balcony shades can be mounted on their side. (See Figure A). Use the vertical measurement as your width (max. 36") and the horizontal measurement as your length (max. 48").
- Polycarbonate track system provides superior insulation and light blocking. The enclosed sides provide full privacy.
- No exposed cords, eliminates risk of injury to children.

### Balcony Vertical Applications

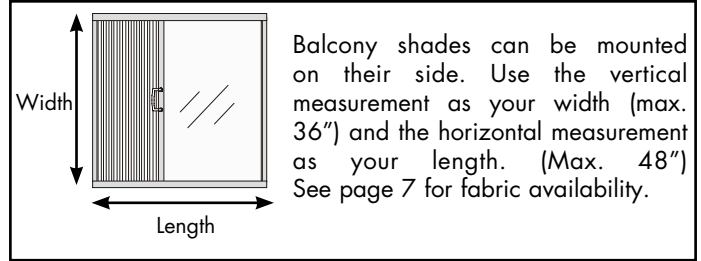

Figure A

### Maximum Shade Area

Maximum shade areas (in square feet) varies with slope and fabric type.

	Horizontal	Angled	Vertical
Symphony (All)	24	24	18
Debut Light Filtering (All)	24	24	18
Virtuoso (All)	24	24	18

CELLULAR HARDWARE



# Cellular Specialty Shades

## MEZZO 7.4V RECHARGEABLE MOTORIZED SKYLIGHT HARDWARE SYSTEM

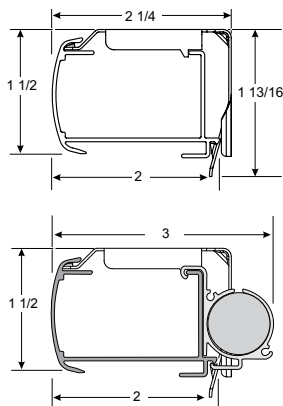

### Simplicity Motorized Rail Dimensions

- Depth of rail: 2"
- Depth of rail and bracket: 2 1/4"
- Height of rail: 1 1/2"
- Height of bracket: 1 13/16"

### Simplicity Motorized Rail with External Battery Dimensions (shades under 20")

- Depth of rail: 2"
- Depth of rail, bracket & battery: 3"
- Height of rail: 1 1/2"
- Height of bracket: 1 13/16"

CELLULAR HARDWARE

### Hardware Features

Hardware colors	White head, bottom and side rails
Simplicity Remotes	Upper and lower limit stops pre-programmed, Intermediate stop "favorites" position can be programmed on-site, 5 Channel, 6 Channel Timer or 14 Channel remote options

### Mounting Dimensions

Mounting Dimensions	Mezzo Motorized Skylight Shades
Minimum Flush Inside Mount	2 1/2"
	<ul style="list-style-type: none"> <li>• Should not be more than 1/2" out of square to perform as intended</li> <li>• The widest width of the window cannot exceed the narrowest width of the window by more than 3/8".</li> <li>• The shade must be mounted with the fabric stack at the bottom or the lowest point of the window</li> </ul>
	See page 83 for Solar Panel Mounting information.

### Finished Dimensions

Inside Mount	
	<ul style="list-style-type: none"> <li>• Fabric will measure ordered width less: 1 1/4"</li> <li>• Head rail* will measure ordered width less: 3/16"</li> </ul>

\* Head rail measurements include endcaps. Width and length measurements may vary +/- 1/8"

### MOTORIZATION - HARDWARE UPGRADE SURCHARGES AND ACCESSORIES | All standard discounts apply to motorized shades

	ADD
Simplicity - Motor and Battery Wand	\$368
Simplicity 5 Channel Remote	\$44
Simplicity 6 Channel Remote with Timer	\$72
48" Extension Wire:	\$19
Simplicity Smart Controller (NEO)	\$363
7.4v Solar Panel & Mounting Brackets	\$110
DC Power Supply	\$70

### Applications

- Horizontal, Angled and Vertical motorized skylight shades.

Mezzo Motorized Skylight Shades are for inside mount applications only.

### Ordering Information for Mezzo Motorized Skylight Shades

- Specify inside mount dimensions.
- Specify fabric color and style.
- Specify remote and other accessories if needed.

# Cellular Specialty Shades

## MEZZO 7.4V RECHARGEABLE MOTORIZED SKYLIGHT HARDWARE SYSTEM

### Applications

- Horizontal, Angled and Vertical motorized skylight shades.

Mezzo Motorized Skylight Shades are for inside mount applications only.

### Mezzo Power Options

- Simplicity Rechargeable Motor

### RECHARGEABLE SIMPLICITY MOTORS

The Simplicity Motor program features a battery powered motor utilizing a rechargeable battery hidden inside the shade head rail. Simplicity motors are compact and use a radio frequency remote to raise or lower the shades.

### Simplicity Rechargeable Battery

The rechargeable battery is concealed in the head rail of the shade. A charger is required for the rechargeable battery. The rechargeable battery comes fully charged from the factory.

Shades with width of 18"- 20" require the battery wand to be mounted externally.

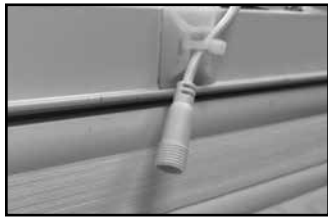

Charging Port on Back of Head rail.



Snap-On external battery for Mezzo shades under 20" in width.

### Simplicity Hand Held Remotes

The **5 Channel (5C) remote** can operate up to five shades individually or 5 groups. Simplicity Rechargeable Motorized Cellular Shades are programmed at the factory with the "up and down" limits. The shades are **UNLINKED** from the remote so they are not able to operate during shipping. Each shade should be installed **after** linking it to the remote.



Simplicity 5C remotes and holders are white or black in color. The remote comes with a holder which can be mounted to a wall for easy storage. The range of the remote is approximately 80 feet.

A **6 Channel (6C) timer remote** is also available. See page 65 for more information

Simplicity remotes and holders are black in color. The remote comes with a holder which can be mounted to a wall for easy storage. The range of the remote is approximately 80 feet.

**14 Channel White Remote also available** (page 56)

The Simplicity remote utilizes one 3V battery (CR2032). Batteries are included. Comfortex will warranty batteries for up to 3 months from date of purchase.

### Solar Panel Recharge Option

Plugs in to any Simplicity Rechargeable Remote control shade (does not work with PowerTouch)

Provides constant trickle charge to 7.4v Li-Ion Rechargeable battery packs. Does not require direct sunlight, but performs best in regular direct sunlight applications. Will prolong the life of the charge of the 7.4v rechargeable battery packs, and in some applications will maintain charge indefinitely.

Life of charge is subject to application variables such as, size and weight of shade, frequency of use, amount of direct sunlight exposure, etc.



Dimensions of panel  
18½" x 1½"

### Solar Recharge Optimum Application

- Full direct sunlight (minimum 4-6 hours per day) to maintain full charge. Based on one operation cycle per day (one open, one close).
- Solar panel will charge batteries even without direct sunlight. Ambient light will charge the batteries but at a slower rate.
- Excessive duration of cloudy weather will impact the rate of charge.

### Battery Charger

8.4 Volt charger requires a standard power outlet to recharge the battery wand. Must specify charger when ordering a Simplicity Rechargeable Wand Shade. The charger plugs into the charger port. The charger is black and comes with a 156" wire. The dimensions are 1" wide x 2½" length x 1¾" deep.





# Cellular Specialty Shades MEZZO MOTORIZED SKYLIGHT HARDWARE SYSTEM

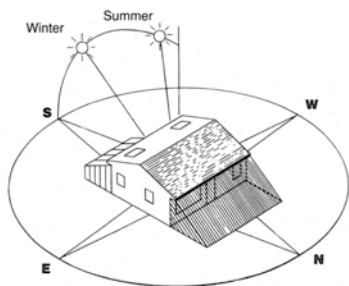

**For Locations North of Washington, DC (39° Latitude)**



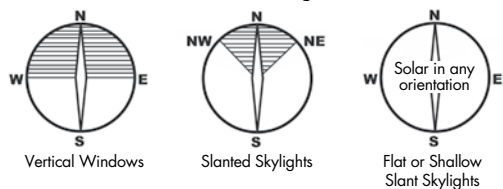

**For Locations South of Washington, DC (39° Latitude)**



- Assumptions:** 1) Window area free from shadows 9 AM to 3 PM.  
2) Glazing is double pane, clear.

Excessive shading or tinted glass will impact the solar charging capability of the system.

-  Indicates orientations which may require periodic manual recharge with Plug In Charger.
-  Indicates orientations which are optimum for solar recharge (wireless systems).

## Important Simplicity Motorized Shades Operating and Installation Information

- Simplicity Motorized Shades installed into windows with metal casings may have a reduced radio frequency range, or may not operate at all, depending on the application.
- Do not let the antenna on the motor touch any metal objects. This may interfere with signals from the remote control.

CELLULAR HARDWARE



# Cellular Specialty Shades

## FRENCH DOOR DÉCOR HARDWARE SYSTEM



### Standard Head Rail

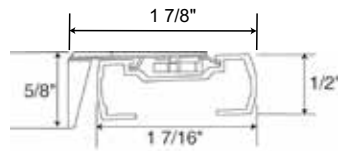

### Deluxe Head Rail

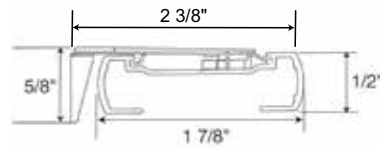

### Standard Rail

- Depth of rail: 1 7/16"
- Depth of rail and bracket: 1 7/8"
- Height of rail: 1/2"
- Height of bracket: 5/8"

### Deluxe Rail

- Depth of rail: 1 7/8"
- Depth of rail and bracket: 2 3/8"
- Height: 1/2"
- Height of bracket: 5/8"

Hardware Features	
Hardware colors	Color coordinated head, middle, bottom rails and end caps
Upgrades	
Fabric Wrapped Upgrade	Fabric used is same fabric as the shade. Back of rail is white to outside. Color coordinated end caps
Designer Metallic Upgrade	<ul style="list-style-type: none"> <li>• Oil Rubbed Bronze head, middle, bottom rails and end caps.</li> <li>• Brushed Nickel head, middle, bottom rails and end caps.</li> </ul>
Mounting Dimensions	
Minimum Shallow Mount	Standard Rail: 3/4"      Deluxe Rail: 3/4"
Minimum Flush Inside Mount	Standard Rail: 2"      Deluxe Rail: 2 1/2"
Minimum Flush Inside Mount (Handle Fully Recessed)	Standard Rail: 2 9/16"      Deluxe Rail: 3"
Minimum Outside Mount	Standard Rail: 3/4"      Deluxe Rail: 3/4"
Minimum Side Mount	Standard Rail: 1 1/8"      Deluxe Rail: 1 3/8"
The widest width of the window cannot exceed the narrowest width of the window by more than 3/8".	
Recommended Side Mounting Method	<ul style="list-style-type: none"> <li>• See page 73 for recommended mounting method for side mount shades</li> <li>• Width limit for side mount brackets is 48"</li> </ul>
Finished Dimensions	
Inside and Side Mount	
	<ul style="list-style-type: none"> <li>• Fabric will measure ordered width less: 3/8"</li> <li>• Head rail* will measure ordered width less: 3/16"</li> </ul>
Outside Mount	
	<ul style="list-style-type: none"> <li>• Fabric will measure ordered width</li> <li>• Head rail* will measure ordered width plus: 3/16"</li> </ul>
Exact (End Cap to End Cap) Mount	
	<ul style="list-style-type: none"> <li>• Fabric will measure ordered width less: 3/16"</li> <li>• Head rail* will measure ordered width</li> </ul>
* Head rail measurements include endcaps. Width and length measurements may vary +/- 1/8"	

CELLULAR HARDWARE

# Cellular Specialty Shades

## FRENCH DOOR DÉCOR HARDWARE SYSTEM

CELLULAR HARDWARE

### Applications

- Stationary Door Décor
- Movable Door Décor
- Top Down - Bottom Up Door Décor
- Cover french doors, transoms, and side lights.

### French Door Décor Hardware Features

- Features two non-moving rails which are mounted in the window or door. A tension control system enables the movable rail to be easily moved with the touch of a finger. The only visible cords are the ones that hold the movable middle rail in place.
- The widest width of the window cannot exceed the narrowest width of the window by more than  $\frac{3}{8}$ ".

### Stationary Non-Movable French Door Décor Shades

- Top and bottom rails are mounted to the window and are stationary.

### Movable French Door Décor Shades

- Top and bottom rails are mounted to the window, one middle movable rail raises from the bottom.

### Top Down - Bottom Up Option

- Top and bottom rails are mounted to the window, two movable rails allow the shade to lower from the top and raise from the bottom.
- The non-movable top and bottom rails are attached to the window or door.
- Ideal for entry ways with narrow windows next to doors and other narrow windows that are easily accessible.

### Ordering Information for French Door Décor

- Specify IB or OB mount and rail color.
- Specify stationary, movable or Top Down - Bottom Up.

### Accessories

- 6' Expandable Pole
- 12' Expandable

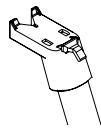

Specially designed pole end allows for easy operation of French Door Décor Shades.

### French Door Decor Cellular Shades Hardware

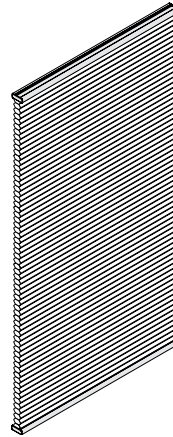

Stationary Non-Movable

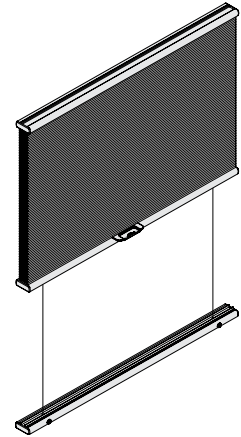

Shown open with movable rail option

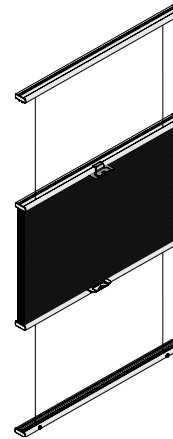

Shown open with Top Down - Bottom Up Option

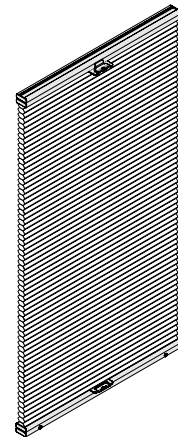

Shown closed with Top Down - Bottom Up Option

# Cellular Specialty Shades

## DAY-NIGHT SHADES HARDWARE SYSTEM



### Standard Cord Lock Rail

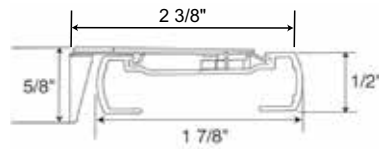
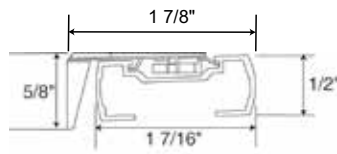

### Standard Cord Lock Rail

- Depth of rail: 1 7/8"
- Depth of rail and bracket: 1 7/8"
- Height of rail: 1/2"
- Height of bracket: 5/8"

### Deluxe Cord Lock Rail

- Depth of rail: 1 7/8"
- Depth of rail and bracket: 2 3/8"
- Height: 1/2"
- Height of bracket: 5/8"

Hardware Features	
Hardware colors for all Cellular fabrics	Color coordinated head, middle and bottom rails with white cord and tassel. See additional details on page 88.
Upgrades	
Fabric Wrapped Upgrade	Fabric used is same fabric as the shade. Back of rail is white to outside. Color coordinated end caps.
Designer Metallic Upgrade	<ul style="list-style-type: none"> <li>• Oil Rubbed Bronze head and bottom rails with bronze colored tassel, end caps and white cord.</li> <li>• Brushed Nickel head and bottom rails and end caps with coordinating tassel and white cord.</li> </ul>
Mounting Dimensions	
Minimum Shallow Mount	Standard Rail: 3/4"      Deluxe Rail: 3/4"
Minimum Flush Inside Mount	Standard Rail: 2"      Deluxe Rail: 2 3/8"
Minimum Outside Mount	Standard Rail: 3/4"      Deluxe Rail: 3/4"
Minimum Side Mount	Standard Rail: 1 1/16"      Deluxe Rail: 1 3/8"
Recommended Side Mounting Method	<ul style="list-style-type: none"> <li>• See page 73 for recommended mounting method for side mount shades</li> <li>• Width limit for side mount brackets is 48"</li> </ul>
Finished Dimensions	
Inside and Side Mount	
	<ul style="list-style-type: none"> <li>• Fabric will measure ordered width less: 3/8"</li> <li>• Head rail* will measure ordered width less: 3/16"</li> </ul>
Outside Mount	
	<ul style="list-style-type: none"> <li>• Fabric will measure ordered width</li> <li>• Head rail* will measure ordered width plus: 3/16"</li> </ul>
Exact (End Cap to End Cap) Mount	
	<ul style="list-style-type: none"> <li>• Fabric will measure ordered width less: 3/16"</li> <li>• Head rail* will measure ordered width</li> </ul>
* Head rail measurements include endcaps. Width and length measurements may vary +/- 1/8"	

CELLULAR HARDWARE

### Applications

- Standard Rectangular with cellular fabrics only.

### Fabrics

- Some fabrics (i.e. Symphony Blackout) can be used exclusively only as a bottom panel only.

### Day - Night Shade Specifications

Refer to the appropriate fabric sections for proper pricing.

# Cellular Specialty Shades

## DAY-NIGHT SHADES HARDWARE SYSTEM

CELLULAR HARDWARE

### Rail Colors and Cord Colors

- **Color Coordinated Rail Shades:** The top rail and middle rail will coordinate with top fabric and bottom rail will coordinate with the bottom fabric. The cord and tassel will be white. Not available with Color Lux Shades.
- **Designer Metallic Hardware Shades:** All rails, end caps and tassels will be the selected metallic color. Cords will be white.
- **Fabric Wrapped Rail Shades:** The top rail and middle rail will coordinate with top fabric and bottom rail will coordinate with the bottom fabric. The cord and tassel will be white. End caps and cord lock will be color coordinated.

### Ordering Information for Day - Night Shade

- Specify fabrics, top and bottom panels.
- Specify IB or OB mount and rail color.

#### TOP FABRIC

CELLULAR	Width		Length	
	Min	Max	Min	Max
Verona	12"	72"	18"	96"
Boutique	12"	72"	18"	96"
Debut 1/2" Double Cell Light Filtering	12"	72"	18"	96"
Debut 1/2" Single Cell Light Filtering	12"	72"	18"	96"
Debut 3/4" Single Cell Light Filtering	12"	72"	18"	96"
Linen Weave Light Filtering*	12"	72"	18"	96"
Linen Weave Room Darkening*	NA	NA	NA	NA
Premiere 1/2" Single Cell Blackout	NA	NA	NA	NA
Premiere 1/2" Single Cell Light Filtering	12"	72"	18"	96"
Premiere 3/4" Single Cell Blackout	NA	NA	NA	NA
Premiere 3/4" Single Cell Light Filtering	12"	72"	18"	96"
Aspen 3/8" Double Cell Light Filtering	12"	72"	18"	96"
Symphony 3/8" Double Cell Blackout	NA	NA	NA	NA
Symphony 3/8" Double Cell Light Filtering	12"	72"	18"	96"

#### BOTTOM FABRIC

Width		Length	
Min	Max	Min	Max
12"	72"	18"	96"
12"	72"	18"	96"
12"	72"	18"	96"
12"	72"	18"	96"
12"	72"	18"	96"
12"	72"	18"	96"
12"	72"	18"	96"
12"	72"	18"	96"
12"	72"	18"	96"
12"	72"	18"	96"
12"	72"	18"	96"
12"	72"	18"	96"
12"	72"	18"	96"
12"	72"	18"	96"

\* Day-Night Shades can only be built in conjunction with other 3/4" cellular fabrics. All Debut includes print patterns: Strie, Terazzo, Angel Hair, Strat, Florance, Blossom, Country Woven and Homespun.

# Cellular Specialty Shades

## CUSTOM GRAPHICS

### Custom Graphics

With Custom Graphics, you can print anything on a Cellular Shade. From logos to personal photos, theme room graphics or advertising for your storefront, anything you envision can be featured on a Custom Graphics Cellular Shade.

### Hardware | Mounting | Finished Dimensions

See Page 47

### Available Fabrics

Custom Graphics are available with the following fabrics:

- Premiere 1/2" and 3/4" Light Filtering Fabrics
- Premiere 1/2" and 3/4" Blackout Fabrics

### Custom Graphics can work for any window.

#### Advertising and Store Identification

Contact local businesses and explain how you can to turn their window space into advertising!



### Decorative and Personal Photos

Customers can now convert their special photos into a highly personalized room!

### Printing Information and Options

Custom Graphics will look different from fabric to fabric. The color vibrancy on cellular shades will be muted due to the density of the fabrics and the printing process.

To view the color differences on Cellular Shades, visit the Custom Graphic section of the Comfortex Dealers website.

### Single Sided Printing:

Cellular Custom Graphics are available as single-sided only. Double-sided graphics are not available.

You can choose to have Side A face the room side or the street side.



Side A  
Shows Printed Image



Side B  
White Fabric

CELLULAR HARDWARE

## Ordering Information for Custom Graphics Cellular Shades

### Step 1. Fill out the Custom Graphics Cellular Shades

**Order Form.** This form includes your fabric and hardware selections. Fax the completed order form to (800) 336-4580 to place your order.

Custom Graphic orders can only be placed by faxing this form.

**Step 2. Receive your Comfortex Work Order Confirmation number.** Be sure to reference this number when submitting you artwork in Step 3.

**Step 3. Send your graphic files via email to: CustomGraphics@Comfortex.com**

Or ship a CD containing your graphics to:  
 Custom Graphics  
 Comfortex Window Fashions  
 21 Elm Street  
 Maplewood, NY 12189

### Graphic File Specifications

Preferred Formats:

- Adobe Illustrator
- EPS

Other Accepted Formats:

- TIFF
- JPEG
- PSD

- All typography should be converted to paths when submitting an Illustrator or EPS file.
- TIFF and JPEG files should be submitted at the largest size possible, 300 DPI is preferred. We will size your graphics according to your shade size and specifications.
- Contact Comfortex Customer Care at 800-843-4151 with all questions regarding Custom Graphic Orders.
- Comfortex will not print any copyrighted custom graphics without appropriate permission.

**Step 4. The Custom Graphic Team will email a PDF proof of your shade order for you to approve.** Once the artwork is approved, it will take two weeks for your order to be printed, assembled, and shipped.

**Prelude Cellular  
STANDARD CORD LOCK SHADES HARDWARE SYSTEM**

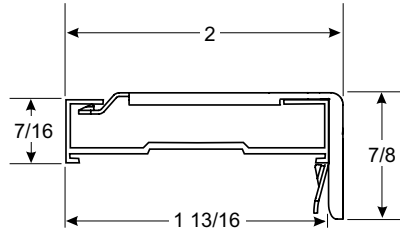

**Cord Lock Rail Dimensions**

- Depth of rail: 1 13/16"
- Depth of rail and bracket\*: 2"
- Height of rail: 7/16"
- Height of bracket: 7/8"

\*Depth of rail (including Cord Lock mechanism) and bracket is 2 3/8"

<b>Hardware Features</b>	
Standard Hardware colors for Comfortex Prelude	Color coordinated head, middle and bottom rails with color coordinated cord and tassel.
<b>Upgrades</b>	
Fabric Wrapped Upgrade	Not Available on Cord Lock Shades
Designer Metallic Upgrade	Not Available on Cord Lock Shades
<b>Mounting Dimensions</b>	
	<b>Standard Bracket</b> <b>Swivel Bracket</b> <b>End Mount Bracket</b>
Minimum Depth Inside Mount	1 1/4"      1/2"      NA
Minimum Flush Inside Mount	2 1/4"      2"      2"
Minimum Outside Mount	1"      1"      1"
Maximum End Mount Shade width 36"	
<b>Finished Dimensions</b>	
<b>Inside Mount</b>	
	<ul style="list-style-type: none"> <li>• Fabric will measure ordered width less: 3/8"</li> <li>• Head rail* will measure ordered width less: 3/16"</li> <li>• Length will measure ordered length</li> </ul>
<b>Outside Mount</b>	
	<ul style="list-style-type: none"> <li>• Fabric will measure ordered width</li> <li>• Head rail* will measure ordered width plus: 3/16"</li> <li>• Length will measure ordered length</li> </ul>
<b>Cord Length</b>	
	<ul style="list-style-type: none"> <li>• Comfortex complies with all WCMA/ANSI standards and as such the default cord length will be 40% of the ordered shade length. Custom lengths are available.</li> </ul>
* Head rail measurements include endcaps. Width and length measurements may vary +/- 1/8"	
<b>NOTE: An additional 1/4" width deduction is taken on shades ordered Inside Mount with hold down brackets.</b>	

PRELUDE HARDWARE

# Prelude Cellular

## STANDARD CORD LOCK SHADES HARDWARE SYSTEM

---

### Applications

- Standard Rectangular
- Top Down - Bottom Up
- Two-On-One Head Rail

### Things to Consider

- If child or pet safety is a concern, consider Cordless Ultra.
- Larger shades can be difficult to operate. Consider Cord Loop hardware.
- If privacy is an issue, consider Top Down-Bottom Up options.

---

### Ordering Information for Standard Cord Lock Shades

#### Standard Rectangular

- Specify IB or OB mount, and left or right lift cord.

#### Top Down - Bottom Up

- Specify IB or OB mount.  
Top Down - Bottom Up Shades are made with two operating cord locks, one on the left and one on the right side of shade. The right cord operates the middle rail and left cord operates the bottom.
- On Top Down - Bottom Up Shades, an extra two-cell fabric gasket attached to the top head rail and acts as a seal to eliminate light leakage between the head rail and middle rail when the shade is closed.



#### Two-On-One Head Rail

Two-On-One Head Rail Shades operate as two separate shades on one head rail.

- Specify IB or OB mount.
- Specify panel sizes.
- Maximum width in a single panel depends on fabric type. See page 2 for maximum single panel width.
- 1/4" to maximum 1/2" Space between panels.



**Prelude Cellular  
CORD LOOP HARDWARE SYSTEM**

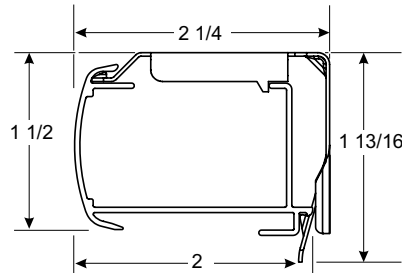

**Cord Loop Rail Dimensions**

- Depth of rail: 2"
- Depth of rail and bracket: 2 1/4"
- Height of rail: 1 1/2"
- Height of bracket: 1 13/16"

<b>Hardware Features</b>	
Standard Hardware colors for Comfortex Prelude	Color coordinated head, bottom rails and end caps with a white cord and tensioner
<b>Upgrades</b>	
Fabric Wrapped Upgrade	Fabric used is same fabric as the shade. Back of rail is white to outside. Color coordinated end caps for rails.
Designer Metallic Upgrade	<ul style="list-style-type: none"> <li>• Smooth faced Oil Rubbed Bronze head, bottom rails and end caps with bronze tensioner and bronze cord.</li> <li>• Smooth faced Brushed Nickel head, bottom rails and end caps with coordinating tensioner and cord.</li> </ul>

**PRELUDE HARDWARE**

<b>Mounting Dimensions</b>	<b>Cord Loop Hardware System</b>
Minimum Inside Mount	3/4"
Minimum Flush Inside Mount	2 1/8"
Minimum Outside Mount Flat Vertical Surface	1 1/2"
Maximum End Mount Shade width 48"	

<b>Finished Dimensions -Standard Rectangular and Top Down-Bottom Up</b>	
<b>Inside Mount</b>	
	<ul style="list-style-type: none"> <li>• Fabric will measure ordered width less: 3/8"</li> <li>• Head rail* will measure ordered width less: 1/4"</li> <li>• Length will measure ordered length</li> </ul>
<b>Inside Mount with Hold Down Brackets</b>	
	<ul style="list-style-type: none"> <li>• Fabric will measure ordered width less: 5/8"</li> <li>• Head rail* will measure ordered width less: 1/2"</li> <li>• Bottom rail* will measure ordered width less: 1/2"</li> <li>• Length will measure ordered length</li> </ul>
<b>Outside Mount</b>	
	<ul style="list-style-type: none"> <li>• Fabric will measure ordered width less: 1/8"</li> <li>• Head rail* will measure ordered width</li> <li>• Length will measure ordered length</li> </ul>
* Head rail measurements include endcaps. Width and length measurements may vary +/- 1/8"	

**NOTE: An additional 1/4" width deduction is taken on shades ordered Inside Mount with hold down brackets.**

**Prelude Cellular  
CORD LOOP HARDWARE SYSTEM**

<b>Finished Dimensions -Two-On-One</b>	
<b>Inside Mount</b>	
	<ul style="list-style-type: none"> <li>• Fabric will measure ordered width less: <math>\frac{5}{8}</math>"</li> <li>• Head rail* will measure ordered width less: <math>\frac{1}{4}</math>"</li> <li>• Length will measure ordered length</li> </ul>
<b>Outside Mount</b>	
	<ul style="list-style-type: none"> <li>• Fabric will measure ordered width less: <math>\frac{1}{8}</math>"</li> <li>• Head rail* will measure ordered width</li> <li>• Length will measure ordered length</li> </ul>
<p>* Head rail measurements include endcaps. Width and length measurements may vary +/- <math>\frac{1}{8}</math>"</p>	

**NOTE: An additional  $\frac{1}{4}$ " width deduction is taken on shades ordered Inside Mount with hold down brackets.**

**Applications**

- Standard Rectangular
- Top Down - Bottom Up
- Two-On-One Head Rail

**Cord Loop Hardware System Features**

Cord loops are available 18" to 10' lengths. Please specify length when ordering. Standard loop sizes are as follows:

Shade Length	Standard Loop
Up to 18"	18"
18" to 42"	2' (24")
42 $\frac{1}{8}$ " to 54"	3' (36")
54 $\frac{1}{8}$ " to 72"	4' (48")
72 $\frac{1}{8}$ " to 90"	5' (60")
90 $\frac{1}{8}$ " to 110"	6' (72")
110 $\frac{1}{8}$ " and greater	8' (96")

**Ordering Information for Cord Loop Hardware Shades**

**Standard Rectangular**

- Specify IB or OB mount, and left or right cord loop.
- Specify cord loop length when ordering.

**Top Down - Bottom Up**

- Specify IB or OB mount.  
Specify cord loop length when ordering.
- Controls are the right cord loop operates the middle rail and left cord loop operates the bottom. Reverse controls are not available.
- On Top Down-Bottom Up shades a fabric insert is standard; this is an extra 2 cell fabric gasket attached to the top head rail and acts as a seal to eliminate light leakage between the head rail and center rail when the shade is closed

**Two-On-One Head Rail**

- Two-On-One Head Rail Shades operate as two separate shades on one head rail.
- Specify IB or OB mount.
- Specify panel sizes.
- Specify cord loop length when ordering.
- See page 2 for maximum single panel width.
- $\frac{1}{4}$ " Space between panels.

**PRELUDE HARDWARE**

**Prelude Cellular  
CORDLESS ULTRA HARDWARE SYSTEM**

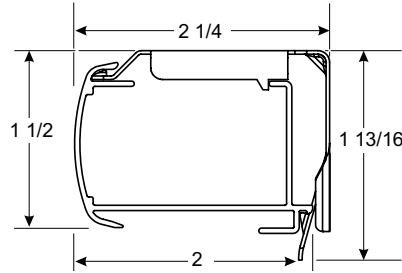
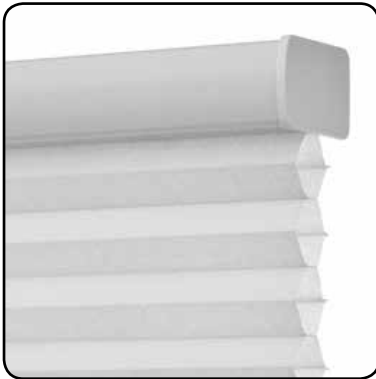

**Cord Loop Rail Dimensions**

- Depth of rail: 2"
- Depth of rail and bracket: 2 1/4"
- Height of rail: 1 1/2"
- Height of bracket: 1 13/16"

<b>Hardware Features</b>	
Standard Hardware colors for Comfortex Prelude	Color coordinated head, middle and bottom rails.
<b>Upgrades</b>	
Fabric Wrapped Upgrade	Fabric used is same fabric as the shade. Back of rail is white to outside. End caps on fabric wrapped head, middle and bottom rails are color coordinated
Designer Metallic Upgrade	<ul style="list-style-type: none"> <li>• Smooth faced Designer Oil Rubbed Bronze head, middle, bottom rails and end caps</li> <li>• Smooth faced Designer Brushed Nickel head, middle, bottom rails and end caps</li> </ul>

**PRELUDE HARDWARE**

<b>Mounting Dimensions</b>	<b>Cordless Ultra Hardware System</b>
Minimum Inside Mount	3/4"
Minimum Flush Inside Mount	2 1/8"
Minimum Outside Mount Flat Vertical Surface	1 1/2"
Maximum End Mount Shade width 48"	

<b>Finished Dimensions</b>	
<b>Inside Mount</b>	
	<ul style="list-style-type: none"> <li>• Fabric will measure ordered width less: 3/8"</li> <li>• Head rail* will measure ordered width less: 1/4"</li> <li>• Length will measure ordered length</li> </ul>
<b>Inside Mount with Hold Down Brackets</b>	
	<ul style="list-style-type: none"> <li>• Fabric will measure ordered width less: 5/8"</li> <li>• Head rail* will measure ordered width less: 1/2"</li> <li>• Bottom rail* will measure ordered width less: 1/2"</li> <li>• Length will measure ordered length</li> </ul>
<b>Outside Mount</b>	
	<ul style="list-style-type: none"> <li>• Fabric will measure ordered width less: 1/8"</li> <li>• Head rail* will measure ordered width</li> <li>• Length will measure ordered length</li> </ul>
<b>End Mount/Side Mount</b>	
	<ul style="list-style-type: none"> <li>• Fabric will measure ordered width less: 5/8"</li> <li>• Head rail* will measure ordered width less: 1/2"</li> <li>• Length will measure ordered length</li> </ul>

\* Head rail measurements include endcaps. Width and length measurements may vary +/- 1/8"

**NOTE: An additional 1/4" width deduction is taken on shades ordered Inside Mount with hold down brackets.**

# Prelude Cellular CORDLESS ULTRA HARDWARE SYSTEM

## Applications

- Standard Rectangular
- Top Down - Bottom Up
- Two-On-One Head Rail
- Three-On-One Head Rail

## Ordering Information for Cordless Ultra Hardware Shades

### Standard Rectangular

- Specify IB or OB mount.

### Top Down - Bottom Up

- Specify IB or OB mount.

## Accessories

- 6' Expandable Pole 

Specially designed pole end fits into the handle on the bottom rail and allows for easy operation.

## Things to Consider

- Is the top of your window out of reach? You can order an extension pole to reach but it can still be tricky. You may want to consider Cord Loop hardware.
- For shades mounted on doors, you may want to order hold down brackets.
- If privacy is an issue, consider Top Down-Bottom Up options.

CORDLESS THREE-ON-ONE SIZE STANDARDS*	
Minimum Width (per panel)	16"
Minimum Width (Overall)	48"
Maximum Width (per panel)	120"
Maximum Width (Overall)	174"
Minimum Height	12"
Maximum Height	84"
Maximum Area (per panel) (Sq/Ft)	70

\*Three-On-One head rail is not available in Top Down-Bottom Up



PRELUDE HARDWARE

# Prelude Cellular CORDLESS LIFT & LOCK HARDWARE SYSTEM

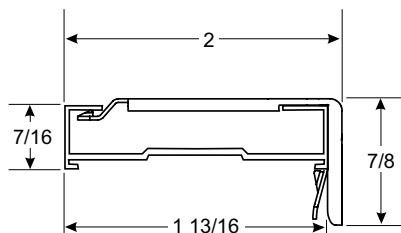

### Cord Lock Rail Dimensions

- Depth of rail: 1 13/16"
- Depth of rail and bracket: 2"
- Height of rail: 7/16"
- Height of bracket: 7/8"

Hardware Features	
Standard Hardware colors for Comfortex Prelude	Color coordinated head, middle and bottom rails with color coordinated push button/handle on the middle and/or bottom rails
Upgrades	
Fabric Wrapped Upgrade	Fabric used is same fabric as the shade. Back of rail is white to outside. All shades will have a white push button/handle on the middle /bottom rail. White end caps.

PRELUDE HARDWARE

Mounting Dimensions	Standard Head Rail
Minimum Inside Mount	3/4"
Minimum Flush Inside Mount	2 1/8"
Minimum Outside Mount Flat Vertical Surface	1 1/2"
Maximum End Mount Shade width 48"	
Finished Dimensions	
Inside Mount	
	<ul style="list-style-type: none"> <li>• Fabric will measure ordered width less: 3/8"</li> <li>• Head rail* will measure ordered width less: 3/16"</li> </ul>
Outside Mount	
	<ul style="list-style-type: none"> <li>• Fabric will measure ordered width less: 1/8"</li> <li>• Head rail* will measure ordered width</li> </ul>
End Mount/Side Mount	
	<ul style="list-style-type: none"> <li>• Fabric will measure ordered width less: 1/2"</li> <li>• Head rail* will measure ordered width less: 1/2"</li> </ul>
* Head rail measurements include endcaps. Width and length measurements may vary +/- 1/8"	

**NOTE: An additional 1/4" width deduction is taken on shades ordered Inside Mount with hold down brackets**

# Prelude Cellular CORDLESS LIFT & LOCK HARDWARE SYSTEM

## Applications

- Standard Rectangular
- Top Down - Bottom Up
- Two-On-One Head Rail
- Three-On-One Head Rail

## Ordering Information for Cordless Lift & Lock Hardware Shades

### Standard Rectangular

- Specify IB or OB mount and rail color.

### Top Down - Bottom Up

- Specify IB or OB mount.

## Things to Consider

- To operate a Cordless Lift & Lock Shade, the middle or bottom rails must be accessible. An extension pole is not available for Cordless Lift & Lock Shades.
- For shades mounted on doors, you may want to order hold down brackets.
- If privacy is an issue, consider Top Down-Bottom Up options.

## Cordless Lift & Lock Shade Operation

Cordless Lift & Lock Shades are operated using the push button handle located in the center of the bottom rail.

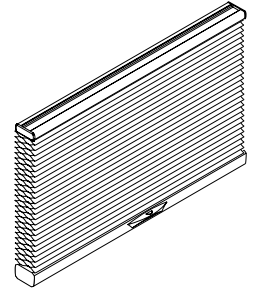

To raise or lower the shade; press the button on the shade handle, and guide the rail to desired position. Release the button to lock the shade into place.

The shade will hold any position when the button is released. Raise the shade slowly and steadily to allow the shade to stack evenly.

CORDLESS THREE-ON-ONE SIZE STANDARDS*	
Minimum Width (per panel)	16"
Minimum Width (Overall)	48"
Maximum Width (per panel)	120"
Maximum Width (Overall)	174"
Minimum Height	12"
Maximum Height	84"
Maximum Area (per panel) (Sq/Ft)	70

\*Three-On-One head rail is not available in Top Down-Bottom Up



PRELUDE HARDWARE

Prelude Cellular

7.4V RECHARGEABLE SIMPLICITY MOTORIZED HARDWARE SYSTEM

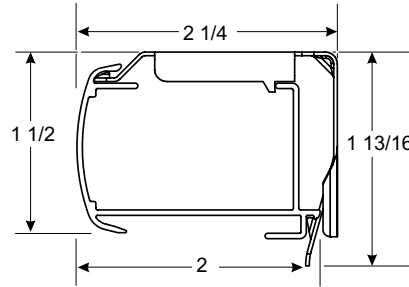

**Rechargeable Simplicity Rail Dimensions**

- Depth of rail: 2"
- Depth of rail and bracket: 2 1/4"
- Height of rail: 1 1/2"
- Height of bracket: 1 13/16"

**Hardware Features**

Hardware colors for all Cellular and Pleated fabrics (Symphony Blackout Not Available)	Color coordinated head, bottom rails and end caps
Standard Hardware for all Custom Graphics	White head and bottom rails and end caps
<b>Upgrades</b>	
Fabric Wrapped Upgrade	Fabric used is same fabric as the shade. Back of rail is white to outside. End caps on fabric wrapped head and bottom rails are color coordinated
Designer Metallic Upgrade	<ul style="list-style-type: none"> <li>• Smooth faced Oil Rubbed Bronze head, bottom rails and end caps</li> <li>• Smooth faced Brushed Nickel head, bottom rails and end caps</li> </ul>

PRELUDE HARDWARE

**Mounting Dimensions**

**Rechargeable Simplicity Motorization Hardware System**

Minimum Shallow Mount	1/2"
Minimum Flush Inside Mount	2 1/4"
Minimum Outside Mount	7/8"
Minimum Side Mount	1 1/4"
Minimum Flush Side Mount	2 1/4"
<b>Recommended Side Mounting Method</b>	<ul style="list-style-type: none"> <li>• See page 73 for recommended mounting method for side mount shades</li> <li>• Width limit for side mount brackets is 48"</li> </ul>

**Finished Dimensions**

**Inside Mount**

- Fabric will measure ordered width less: 3/8"
- Head rail\* will measure ordered width less: 3/16"

**Outside Mount**

- Fabric will measure ordered width
- Head rail\* will measure ordered width plus: 3/16"

**Side Mount**

- Fabric will measure ordered width less: 7/8"
- Head rail\* will measure ordered width less: 1 1/16"

**Exact (End Cap to End Cap) Mount**

- Fabric will measure ordered width less: 3/16"
- Head rail\* will measure ordered width

\* Head rail measurements include endcaps. Width and length measurements may vary +/- 1/16"

## Prelude Cellular

### 7.4V RECHARGEABLE SIMPLICITY MOTORIZED HARDWARE SYSTEM \_\_\_\_\_

#### Rechargeable Simplicity Motors

The Simplicity Motor program features a battery powered motor utilizing a rechargeable battery hidden inside the shade head rail. Simplicity motors are compact and use a radio frequency remote to raise or lower the shades.

Rechargeable Motorized Lift Systems are not offered on sizes within the shaded area on the Standard Rectangular price grids.

#### Applications

- Standard Rectangular
- Top Down-Bottom Up
- Two-On-One Head Rail Bottom Up
- Two-On-One Head Rail Top Down-Bottom Up

#### EZ Level

Learn about the EZ Level feature on page 122.

#### Rechargeable Simplicity Motorization Surcharges

The Rechargeable Simplicity Motorized Lift System surcharge includes a rechargeable battery. Remotes are needed to operate the shades. Refer to pricing pages.

#### Important Simplicity Motorized Shade Operating and Installation Information

- Simplicity Motorized Shades installed into windows with metal casings may have a reduced radio frequency range, or may not operate at all, depending on the application.
- Do not let the antenna on the motor touch any metal objects. This may interfere with signals from the remote control.

#### Simplicity Rechargeable Battery

The rechargeable battery is concealed in the head rail of the shade. A charger is required for the rechargeable battery. The rechargeable battery comes fully charged from the factory.

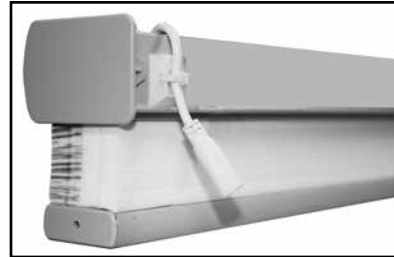

Charging Port on Back of Head rail.

#### RECHARGEABLE SIMPLICITY PRICING EXAMPLE:

Linen Weave	
Light Filtering 42" x 60" Shade:	\$422.00
Simplicity Rechargeable Surcharge:	\$368.00
Charger for Rechargeable :	\$30.00
Simplicity Remote Control:	\$44.00
<b>Total List Price:</b>	<b>\$864.00</b>



## Prelude Cellular

### 7.4V RECHARGEABLE SIMPLICITY MOTORIZED HARDWARE SYSTEM

#### Simplicity Rechargeable Battery Life

Rechargeable batteries are included with the motor.

The average battery charge will last 6-12 months based on an average sized shade raised and lowered once per day. The life of the battery charge will vary based on the type of window covering selected, the size and weight of the window covering and the number of times the shade is operated on a daily basis.

The battery can be recharged up to 500 times. It takes approximately 5 hours to recharge the motor when fully depleted.

#### Ordering Information for Rechargeable Motorized Cellular Shades

##### Simplicity Motor Option

- Specify IB or OB mount and rail color.
- Specify remote and other accessories if needed.
- Specify one or more battery chargers.

##### Please Note:

- Not all motors run at the same rate of speed.
- Simplicity motors have a "Favorites" position setting. If the homeowner wants to set several shades at the same intermediate position, follow instructions provided with installation manual.
- Simplicity Rechargeable Motorized Cellular Shades are programmed at the factory with the "up and down" limits. The shades are **UNLINKED** from the remote so they are not able to operate during shipping. Each shade should be installed **after** linking it to the remote.
- **REMEMBER: Order at least one charger if ordering rechargeable motors.**

#### Simplicity Motorized Shade Warranty

Please see page 130 for complete Comfortex warranty information.

#### Battery Charger

8.4 Volt charger requires a standard power outlet to recharge the battery wand. Must specify charger when ordering a Simplicity Rechargeable Wand Shade. The charger plugs into the charger port. The charger is black and comes with a 156" wire. The dimensions are 1" wide x 2½" length x 1¾" deep.



#### Simplicity Motor Hand Held Remotes 5 Channel Remote

The **5 Channel (5C) remote** can operate up to five shades individually or 5 groups. Simplicity Rechargeable Motorized Cellular Shades are programmed at the factory with the "up and down" limits. The shades are **UNLINKED** from the remote so they are not able to operate during shipping. Each shade should be installed **after** linking it to the remote.



Simplicity 5C remotes and holders are white or black in color. The remote comes with a holder which can be mounted to a wall for easy storage. The range of the remote is approximately 80 feet.

#### Simplicity Motor Hand Held Remotes Operation

Press the up or down button on the remote to raise or lower the shade to your desired position.

To reprogram channel assignments, please refer to the installation instructions and/or view the video at: [comfortex.com/comfortex-dealers](http://comfortex.com/comfortex-dealers).

The Simplicity remotes utilize one 3V battery. Batteries are included. Comfortex will warranty batteries for up to 3 months from date of purchase. Batteries are not covered by the warranty.

#### Solar Panel Recharge Option

Plugs in to any Simplicity Rechargeable Remote control shade (does not work with PowerTouch)

Provides constant trickle charge to 7.4v Li-Ion Rechargeable battery packs. Does not require direct sunlight, but performs best in direct sunlight applications. Will prolong the life of the charge of the 7.4v rechargeable battery packs, and in some applications will maintain charge indefinitely.

Life of charge is subject to application variables such as, size and weight of shade, frequency of use, amount of direct sunlight exposure, etc.



Dimensions of panel  
18½" x 1½"

Prelude Cellular

7.4V RECHARGEABLE MOTORIZED TOP DOWN-BOTTOM UP HARDWARE SYSTEM

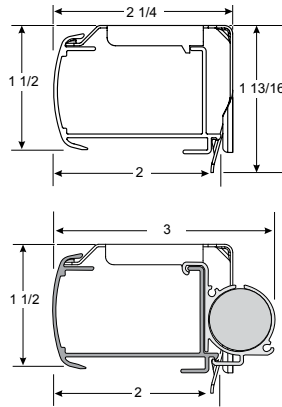

**Simplicity Motorized Rail Dimensions**

- Depth of rail: 2"
- Depth of rail and bracket: 2 1/4"
- Height of rail: 1 1/2"
- Height of bracket: 1 13/16"

**Simplicity Motorized Rail with External Battery Dimensions (shades under 36")**

- Depth of rail: 2"
- Depth of rail, bracket & battery: 3"
- Height of rail: 1 1/2"
- Height of bracket: 1 13/16"

Hardware Features	
Standard Hardware	<ul style="list-style-type: none"> <li>• Color coordinated head, middle, and bottom rails. Head rail and Bottom rails will have frosted end caps with fabric inserts.</li> </ul>
14 Channel TDBU Remote	Upper and lower limit stops pre-programmed
Upgrades	
Designer Metallic Upgrade	<ul style="list-style-type: none"> <li>• Smooth faced Designer Oil Rubbed Bronze head, middle, bottom rails and end caps</li> <li>• Smooth faced Designer Brushed Nickel head, middle, bottom rails and end caps</li> </ul>
Fabric Wrapped Rails	<ul style="list-style-type: none"> <li>• Fabric used to cover the rails is the same fabric as the shade. The back of the rail will be white to the outside. End Caps will be color coordinated.</li> </ul>

Mounting Dimensions	Simplicity Motorized Hardware System
Minimum Shallow Mount	1/2"
Minimum Flush Inside Mount	2 1/4"
Minimum Outside Mount	7/8"
Minimum Side Mount	1 1/4"
<b>Recommended Side Mounting Method</b>	<ul style="list-style-type: none"> <li>• See page 73 for recommended mounting method for side mount shades</li> <li>• Width limit for side mount brackets is 48"</li> </ul>

**Finished Dimensions**

Inside Mount	
	<ul style="list-style-type: none"> <li>• Fabric will measure ordered width less: 3/8"</li> <li>• Head rail* will measure ordered width less: 3/16"</li> </ul>
Outside Mount	
	<ul style="list-style-type: none"> <li>• Fabric will measure ordered width</li> <li>• Head rail* will measure ordered width plus: 3/16"</li> </ul>
Side Mount	
	<ul style="list-style-type: none"> <li>• Fabric will measure ordered width less: 7/8"</li> <li>• Head rail* will measure ordered width less: 1 1/16"</li> </ul>
Exact (End Cap to End Cap) Mount	
	<ul style="list-style-type: none"> <li>• Fabric will measure ordered width less: 3/16"</li> <li>• Head rail* will measure ordered width</li> </ul>

\* Head rail measurements include endcaps. Width and length measurements may vary +/- 1/8"

PRELUDE HARDWARE

## Prelude Cellular

### 7.4V RECHARGEABLE MOTORIZED TOP DOWN-BOTTOM UP HARDWARE SYSTEM

#### Rechargeable Simplicity Motors

The Simplicity TDBU Motor program features a battery powered motor utilizing a rechargeable battery hidden inside the shade head rail. If shades are less than 36" in width, an external snap-on battery pack is necessary.

(See picture to right)

#### Applications

- TDBU Rectangular/ Two-On-One Head Rail

#### EZ Level

Learn about the EZ Level feature on page 122.

#### Rechargeable Simplicity Motorization Surcharges

The Rechargeable Simplicity Motorized Lift System surcharge includes a rechargeable battery. Remotes are needed to operate the shades. Refer to pricing pages.

#### Ordering Information for Top Down-Bottom Up Motorized Cellular Shades

##### Simplicity Motor Option

- Specify IB or OB mount and rail color.
- 14 Channel TDBU Remote is required.
- Specify one or more battery chargers.

##### Please Note:

- Shades that are 24"-36" in width will have an external battery.
- Shades with an external battery and OB mounted will need spacer blocks.
- Simplicity Rechargeable Motorized Cellular Shades are programmed at the factory with the "up and down" limits.
- **REMEMBER: Order at least one charger if ordering rechargeable motors.**

#### Top Down-Bottom Up Simplicity Motor Hand Held 14 Channel Remote

The TDBU remote has 14-channels. Each channel has a setting able to operate the middle rail and a setting able to operate the bottom rail. The TDBU remote is required for TDBU motors, but can be used with other motors as well. The **14 Channel TDBU remote** can operate up to fourteen shades individually or 14 groups. Simplicity Rechargeable Motorized Cellular Shades are programmed at the factory with the "up and down" limits. The shades are **UNLINKED** from the remote so they are not able to operate during shipping. Each shade should be installed **after** linking it to the remote.

Simplicity TDBU remotes and holders are white in color. The remote comes with a holder which can be mounted to a wall for easy storage. The range of the remote is approximately 80 feet. A **14 Channel (14C) remote** can be utilized on all Simplicity motorized shades.



#### Simplicity Rechargeable Battery for TDBU

The rechargeable battery is concealed in the head rail of the shade. A charger is required for the rechargeable battery. The rechargeable battery comes fully charged from the factory.

Rechargeable Battery Pack is concealed in the head rail. Minimum width of 36" is required otherwise battery wand must be mounted externally.

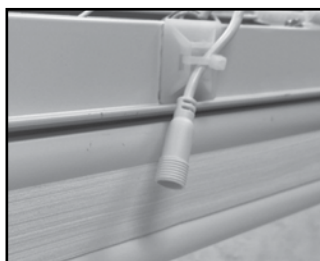

Charging Port on Back of Head rail.

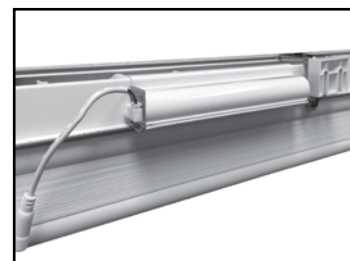

Snap-On external battery for TDBU shades 36" or less in width. Spacer block also required for outside mount.

#### Battery Charger

8.4 Volt charger requires a standard power outlet to recharge the battery wand. Must specify charger when ordering a Simplicity Rechargeable Wand Shade. The charger plugs into the charger port. The charger is black and comes with a 156" wire. The dimensions are 1" wide x 2 1/2" length x 1 3/4" deep.

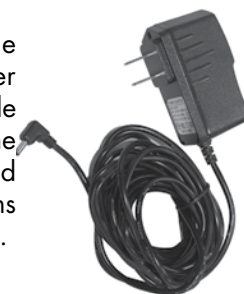

#### Solar Panel Recharge Option

Plugs in to any Simplicity Rechargeable Remote control shade (does not work with PowerTouch). See page 58.



Dimensions of panel 18 1/2" x 1 1/2"

#### PRELUDE MOTORIZED TOP DOWN-BOTTOM UP PRICING EXAMPLE:

Linen Weave	
Light Filtering 42" x 60" Shade:	\$242.00
Simplicity Rechargeable TDBU Surcharge:	\$589.00
Charger for Rechargeable:	\$30.00
TDBU Remote Control:	\$72.00
<b>Total List Price:</b>	<b>\$933.00</b>

PRELUDE HARDWARE

**Prelude Cellular**

**POWERTOUCH RECHARGEABLE MOTORIZED HARDWARE SYSTEM**

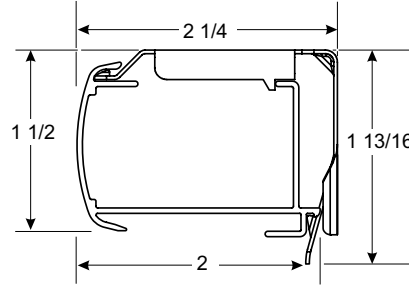
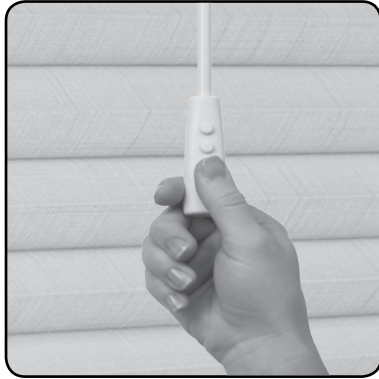

**Simplicity Motorized Rail Dimensions**

- Depth of rail: 2"
- Depth of rail and bracket: 2 1/4"
- Height of rail: 1 1/2"
- Height of bracket: 1 13/16"

<b>Hardware Features</b>	
Hardware colors for all Cellular and Pleated fabrics	Color coordinated head, bottom rails and end caps
Standard Hardware for all Custom Graphics	White head and bottom rails and end caps
PowerTouch Wand	Upper and lower limit stops pre-programmed, Intermediate stop "favorites" position available

<b>Upgrades</b>	
Fabric Wrapped Upgrade	Fabric used is same fabric as the shade. Back of rail is white to outside. End caps on fabric wrapped head and bottom rails are color coordinated
Designer Metallic Upgrade	<ul style="list-style-type: none"> <li>• Smooth faced Oil Rubbed Bronze head, bottom rails and end caps</li> <li>• Smooth faced Brushed Nickel head, bottom rails and end caps</li> </ul>

<b>Mounting Dimensions</b>	<b>Simplicity Motorized Hardware System</b>
Minimum Shallow Mount	1/2"
Minimum Flush Inside Mount	2 1/4"
Minimum Outside Mount	7/8"
Minimum Side Mount	1 1/4"
Minimum Flush Side Mount	2 1/4"
<b>Recommended Side Mounting Method</b>	<ul style="list-style-type: none"> <li>• See page 73 for recommended mounting method for side mount shades</li> <li>• Width limit for side mount brackets is 48"</li> </ul>

<b>Finished Dimensions</b>	
<b>Inside Mount</b>	
	<ul style="list-style-type: none"> <li>• Fabric will measure ordered width less: 3/8"</li> <li>• Head rail* will measure ordered width less: 3/16"</li> </ul>
<b>Outside Mount</b>	
	<ul style="list-style-type: none"> <li>• Fabric will measure ordered width</li> <li>• Head rail* will measure ordered width plus: 3/16"</li> </ul>
<b>Side Mount</b>	
	<ul style="list-style-type: none"> <li>• Fabric will measure ordered width less: 7/8"</li> <li>• Head rail* will measure ordered width less: 1 1/16"</li> </ul>
<b>Exact (End Cap to End Cap) Mount</b>	
	<ul style="list-style-type: none"> <li>• Fabric will measure ordered width less: 3/16"</li> <li>• Head rail* will measure ordered width</li> </ul>

\* Head rail measurements include endcaps. Width and length measurements may vary +/- 1/8"

**PRELUDE HARDWARE**

## Prelude Cellular

### POWERTOUCH RECHARGEABLE MOTORIZED HARDWARE SYSTEM

#### PowerTouch™ Rechargeable Shades

Cellular Shades can be fabricated with the PowerTouch Rechargeable Push Button Control option. The PowerTouch Rechargeable option is an easy, cord free motorized operation for the budget savvy homeowner. PowerTouch Rechargeable uses Simplicity motors and components.

#### PowerTouch Rechargeable Shades Operation

Press the up or down button on the pendant to raise or lower the shade to your desired position.

No programming is required with PowerTouch™, all programming is set at the factory. Upper and lower limits can easily be adjusted in the field if desired. Please refer to the installation instructions at [comfortex.com/](http://comfortex.com/) or [comfortex-dealers.com/](http://comfortex-dealers.com/). A "favorites" or intermediate stop position can be set once installed.

#### PowerTouch Rechargeable Surcharges

See page 10.

#### PowerTouch Appearance

- The PowerTouch wand and pendant is attached to the head rail when installed.
- The wand and pendant hangs down the front of the shades from the head rail. The wand does not touch the fabric.
- Pendant is 2½" long.
- The pendant does not need to be mounted to the wall to operate the shade.



PRELUDE HARDWARE

#### PowerTouch Rechargeable Color Options

- Shades with Black or Oil Rubbed Bronze hardware will be built with black wand and pendants standard. All other colors will use white wand and pendants.



White



Black Shown with Plug-In Charger

#### PowerTouch Wand and Pendant Location

The standard location for the wand and pendant is on the right. Please specify location when ordering.

#### PowerTouch Rechargeable Wand Length

- The standard length of the wand will measure the indicated below unless otherwise specified.

Shading Length	Standard Wand Length
Up to 30"	1' (12")
>30" to 52"	2' (24")
>52" to 78"	3' (36")
>78" to 100"	4' (48")
>100" to 120"	5' (60")

#### Mounting Requirements for PowerTouch Rechargeable Shades

- No special installation hardware or wiring requirements are needed.

#### Battery Charger

8.4 Volt charger requires a standard power outlet to recharge the battery wand. Must specify charger when ordering a Simplicity Rechargeable Wand Shade. The charger plugs into the charger port. The charger is black and comes with a 156" wire. The dimensions are 1" wide x 2½" length x 1¾" deep.



#### PowerTouch Rechargeable Shades Warranty

Please see page 128 for complete warranty information.

**Prelude Cellular**  
**OVATION CELLULAR SLIDER HARDWARE SYSTEM**

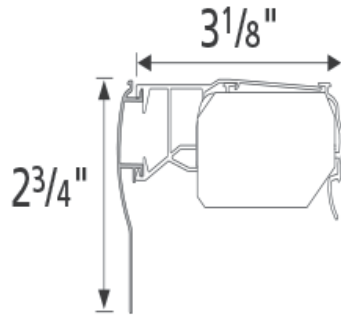

**Ovation Hardware Rail Dimensions**

- Depth of rail and bracket: 3 1/8"
- Valance Height: 2 3/4"
- For each spacer block 1/2" will be added to the length of the valance returns. For extension brackets, 2" will be added unless otherwise instructed.

Hardware Features	
Standard Hardware colors for Comfortex Prelude	Coordinating rail colors have been preselected for each fabric. More colorful fabrics are coordinated to white and off-white rail colors.
Ovation Valance	Every Ovation Slider comes with a painted aluminum valance. The valance attaches to the head rail using a durable plastic clip system.

Mounting Dimensions	Ovation Hardware System
Minimum Inside Mount, Installation Bracket	1 5/16"
Minimum Flush Mount	3 3/8"
Minimum Outside Mount	5/8"
<b>Mounting Specs</b>	<ul style="list-style-type: none"> <li>• For each spacer block, 1/2" will be added to the length of the valance returns. For extension brackets, 2" will be added unless otherwise instructed.</li> <li>• Specify Inside Mount (IB) or Outside Mount (OB) when ordering. If the slider requires a non-flush inside mount, you must order a custom valance.</li> <li>• Exact valance width and exact valance return length (minimum 1 1/2") must be specified in the Special Instructions section of the order form.</li> </ul>

**Finished Dimensions**

Inside Flush Mount	
Track Width:	
Right or Left Stack	3/16" less than ordered width
Split Stack	3/16" less than ordered width
Center Stack	3/16" less than ordered width
Finished Slider Length	1/2" less than ordered width
Valance	3/16" less than ordered width
Outside Mount	
Track Width	3/16" less than ordered width
Finished Slider Length	Ordered length - No reductions will be made
Valance	Ordered width plus 1"
Valance Returns	Will measure 3 1/8" (standard)

PRELUDE HARDWARE

# Prelude Cellular

## OVATION CELLULAR SLIDER HARDWARE SYSTEM

### Applications

- Standard Rectangular
- Opens and closes from side to side
- Four stacking options - see below.

### Ovation Stacking Width

Width	up to 84"	up to 96"	up to 108"	up to 120"
Stack	6½"	7¼"	8"	8¾"

### Minimum Ovation Stack

Ovation's fabric stack measures 6½" regardless of the ordered width. Fabric stacking dimensions are determined by the slider's hardware, not ordered width.

### Things to Consider

- Since most Ovations are sold in large sizes, the shade will have a large fabric stack. On an outside mount, you may want to order the shade a few inches wider so that the fabric stack can be clear of the window.

### Ordering Information for Ovation Cellular Sliders

- Specify IB or OB mount.
- Specify stacking configuration.  
On Split Stack Shades, both panels will be of equal width unless specified.
- Specify valance width and return length.

### Ovation Valance Specifications

- Every Ovation Slider is supplied with a painted aluminum valance.
- The valance attaches to the head rail using a durable plastic clip system.

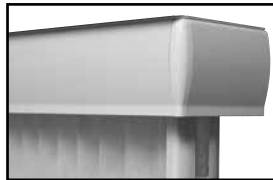

### Ovation Valance Dimensions

All valance dimensions are measured on the flat, back side.

- Valance Height: 2¾"
- Standard Return Length (OB only): 3⅛"
- For each spacer block, ½" will be added to the length of the valance returns. For extension brackets, 2" will be added unless otherwise instructed.

### Vertical Stacking Options

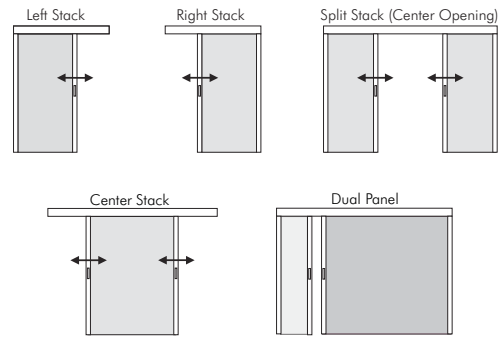

Specify stacking configuration when ordering.

**Left:** Fabric stacks to the left side of the slider.

**Right:** Fabric stacks to the right side of the slider.

**Center Stack:** Center Stack Sliders fabric panels can move fully to the left or the right.

**Split Stack:** Fabric is split in the center of the slider forming two equal panels which open to opposite ends of the slider. Both panels will be of equal width unless otherwise specified.

PRELUDE HARDWARE



# Prelude Cellular STARBURST ARCHES HARDWARE SYSTEM

## Stationary Starburst

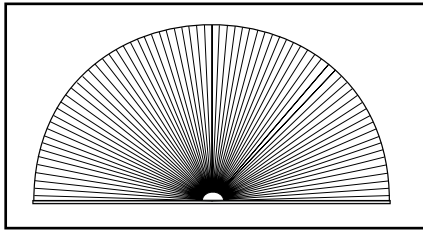

Figure A

## Movable Starburst

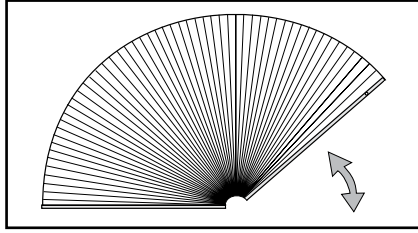

Figure B

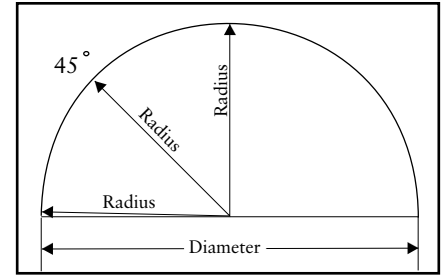

Figure C

Hardware Features	
Standard Hardware colors for Comfortex Prelude	Color coordinated rails
Mounting Dimensions	
Minimum Shallow Mount	3/4"
Minimum Flush Inside Mount	2 3/8"
<b>Recommended Side Mounting Method</b>	• Width limit for side mount brackets is 48"
Finished Dimensions	
Inside and Side Mount	
<ul style="list-style-type: none"> <li>Fabric will measure ordered width less: 3/8"</li> <li>Head rail* will measure ordered width less: 3/16"</li> </ul>	<ul style="list-style-type: none"> <li>* Head rail measurements include endcaps. Width and length measurements may vary +/- 1/8"</li> </ul>

## Applications

- Stationary Fan Style Arch
- Movable Fan Style Arch
- Movable Starburst Arch shades are for inside and shallow mount applications only.

## Stationary Starburst Features (Figure A)

- All non-perfect Stationary Starburst arches require a template.** See page 125 for template instructions.
- All templates should be made from brown craft paper.** Comfortex offers template kits. Please contact Customer Service to order. Stock number: 751000
- A perfect arch is twice as wide as it is high.
- Prelude Stationary Starburst shades must have a height that equals half the width.
- Price according to the largest radius measurement. If the height is greater than the width, take height X 2 and use that number to determine pricing.
- When ordering arches as perfect half-circles make sure the radius of the arch remains constant to ensure a proper fit. (See Figure C)

## Movable Starburst Features (Figure B)

- Starburst Movable archtop shades are cut to perfect half circles only and do not require a template. The height must be exactly 1/2 the diameter.
- A perfect arch is twice as wide as it is high.
- When ordering arches as perfect half circles make sure the radius of the arch remains constant to ensure a proper fit. (See Figure C)
- The hinge gap (gap between the two rails) is not centered in the window. The moving rail is always smaller than the stationary rail to provide proper movement within the window.

## Ordering Information for Sunset Shades

- Specify LB mount and rail color.
- Include a template if the shade is a non-perfect arch.

## Accessories

- 6' Expandable Pole



Specially designed pole end fits into the handle on movable Starburst Shades for easy operation.



# Prelude Cellular SUNSET ARCHES HARDWARE SYSTEM

Movable Sunset

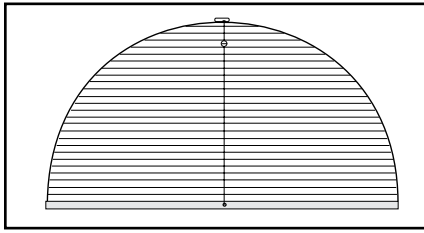

Figure A

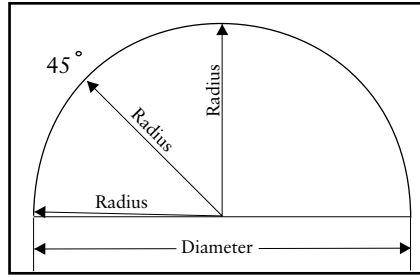

Figure B

Two-String Hanging Method

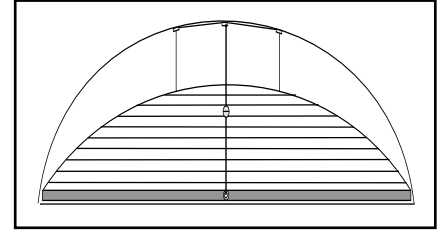

Figure C

## Hardware Features | See Page 47 for Rail Dimensions

Hardware colors for all Prelude	Color coordinated head, middle and bottom rails with white cord and silver tassel
---------------------------------	---

Mounting Dimensions	Standard Rail
Minimum Shallow Mount	3/4"
Minimum Flush Inside Mount	2 3/8"
Minimum Side Mount	1 3/8"
Minimum Flush Side Mount	1 7/8"
<b>Recommended Side Mounting Method</b>	<ul style="list-style-type: none"> <li>• See page 73 for recommended mounting method for side mount shades</li> <li>• Width limit for side mount brackets is 48"</li> </ul>

## Finished Dimensions

Inside and Side Mount	Outside Mount
<ul style="list-style-type: none"> <li>• Fabric will measure ordered width less: 3/8"</li> <li>• Head rail* will measure ordered width less: 3/16"</li> </ul>	<ul style="list-style-type: none"> <li>• Is not offered for Prelude Sunset Top-Down Arches</li> </ul>
<p>* Head rail measurements include endcaps. Width and length measurements may vary +/- 1/8"</p>	

PRELUDE HARDWARE

## Applications

- Movable Arch

## Ordering Information for Sunset Shades

- Include a template if the shade is a non-perfect arch.

## Accessories

- 6' Expandable Pole



Specially designed pole end fits into the ball on Sunset Shades for easy operation.

# Prelude Cellular SUNSET ARCHES HARDWARE SYSTEM

## Sunset Features and Ordering Notes (Figure A)

- Sunset shades have horizontal pleats that stack at the bottom, on a stationary sill rail. Sunset shades are operated by a continuous cord that runs through a top mount guide block and back down through the stationary rail. A moving metal ball attached to the cord is used to raise and lower the shade. (See Figure D).
- **All Sunset arches require a template.** A perfect arch is twice as wide as it is high. See page 125 for template instructions.
- **All templates should be made from brown craft paper.** Comfortex offers template kits. Please contact Customer Service to order. Stock number: 751000
- Sunset shades which are not perfect half circles must have a height which is equal to or greater than 25% of the width.
- When ordering Sunset shades that are perfect half circles, make sure the radius of the arch remains constant to ensure a proper fit. (See Figure B).
- **Stringing Method:** Depending on the curvature of a particular arch, it may be necessary to use the two string method (See Figure C) to ensure proper fit and operation of your Sunset shade. Comfortex will determine the best stringing method after examination of the template.

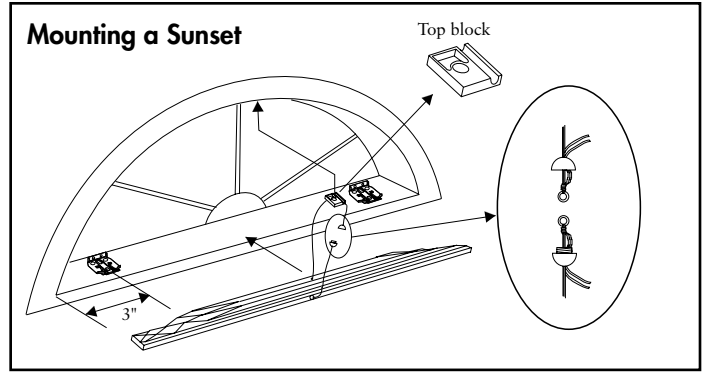

Figure D

## Recommended Mounting Method for Side Mounting Shades

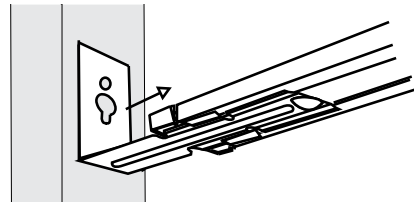

Figure F

Refer to the installation instructions on [Comfortexdealers.com](http://Comfortexdealers.com) or the OnDemand Mobile Library for further details on side mounting shades.

PRELUDE HARDWARE



# Prelude Cellular QUARTER ROUNDS HARDWARE SYSTEM

## Stationary Quarter Round

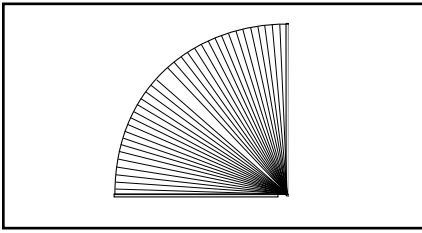

Figure A

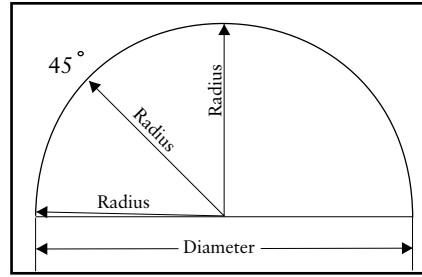

Figure B

### Hardware Features

Hardware colors for all Cellular and Pleated fabrics	Color coordinated rails
--	-------------------------

### Mounting Dimensions

Mounting Dimensions	Standard Rail
Minimum Shallow Mount	3/4"
Minimum Flush Inside Mount	2 3/8"
Minimum Outside Mount	3/4"
Minimum Side Mount	1 3/8"
Minimum Flush Side Mount	1 7/8"

### Recommended Side Mounting Method

- See page 73 for recommended mounting method for side mount shades
- Width limit for side mount brackets is 48"

### Finished Dimensions

#### Inside and Side Mount

- Fabric will measure ordered width less: 3/8"
- Head rail\* will measure ordered width less: 3/16"

#### Outside Mount

- Fabric will measure ordered width
- Head rail\* will measure ordered width plus: 3/16"

#### Exact (End Cap to End Cap) Mount

- Fabric will measure ordered width less: 3/16"
- Head rail\* will measure ordered width

\* Head rail measurements include endcaps. Width and length measurements may vary +/- 1/8"

PRELUDE HARDWARE

### Applications

- Stationary Fan Style Quarter Round

### Ordering Information for Quarter Rounds Shades

- Specify IB or OB mount and rail color.

### Quarter Rounds Features

- Price according to the largest radius measurement.
- **All templates should be made from brown craft paper.** Comfortex offers template kits. Please contact Customer Service to order. Stock number: 751000
- When ordering arches as perfect quarter circles, make sure the radius of the arch remains constant to ensure a proper fit. (See Figure B)

# Prelude Cellular TRAPEZOIDS AND OCTAGONS HARDWARE SYSTEM

## Movable Trapezoids

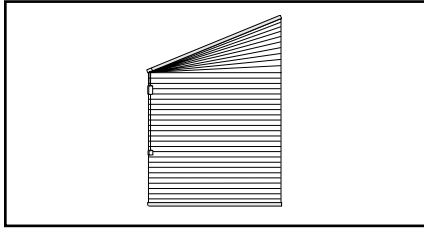

## Movable Octagons

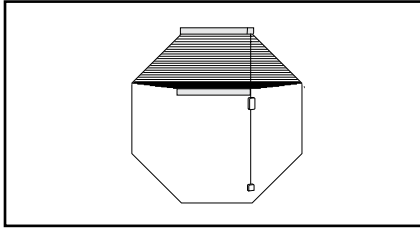

<b>Hardware Features   See Page 47 for Rail Dimensions</b>	
Standard Hardware colors for Comfortex Prelude	Color coordinated head and bottom rails with white cord and tassel
<b>Mounting Dimensions</b>	
Minimum Shallow Mount	3/4"
Minimum Flush Inside Mount	2 3/8"
Minimum Outside Mount	3/4"
Minimum Side Mount	1 3/8"
Minimum Flush Side Mount	1 7/8"
<b>Recommended Side Mounting Method</b>	<ul style="list-style-type: none"> <li>• See page 68 for recommended mounting method for side mount shades</li> <li>• Width limit for side mount brackets is 48"</li> </ul>
<b>Finished Dimensions</b>	
<b>Inside and Side Mount</b>	
	<ul style="list-style-type: none"> <li>• Fabric will measure ordered width less: 3/8"</li> <li>• Head rail* will measure ordered width less: 3/16"</li> </ul>
<b>Outside Mount</b>	
	<ul style="list-style-type: none"> <li>• Fabric will measure ordered width</li> <li>• Head rail* will measure ordered width plus: 3/16"</li> </ul>
<b>Exact (End Cap to End Cap) Mount</b>	
	<ul style="list-style-type: none"> <li>• Fabric will measure ordered width less: 3/16"</li> <li>• Head rail* will measure ordered width</li> </ul>
* Head rail measurements include endcaps. Width and length measurements may vary +/- 1/8"	

**PRELUDE HARDWARE**

### Applications

- Movable Trapezoids
- Movable Octagons

### Ordering Information for Octagon Shades

- Specify IB or OB mount and rail color.
- **The width, length and one side are required measurements when ordering.**

### Ordering Information for Trapezoid Shades

- Specify IB or OB mount and rail color.
- **Trapezoid orders must be faxed in with a diagram. Please provide measurements for all four sides when ordering.**

Prelude Cellular

TRAPEZOIDS AND OCTAGONS HARDWARE SYSTEM

**Trapezoids** (Figure A)

- Trapezoid orders must be faxed in with a diagram. Please provide measurements for all four sides when ordering. Template is required.
- The maximum slope of the top rail is 30 degrees from horizontal. Slope is the angle between slope and a horizontal line. The slope angle must be measured with a protractor.
- Sides of trapezoid must be parallel.
- Sill must be level for proper installation and operation of a trapezoid shade.
- Operating cord must be placed on the short side.
- See Figure B for trapezoid shade operation.

**Octagons**

- The width, length and one side are required measurements when ordering.
- Octagon shades raise only to the point where the top angle begins. (See Figure C)

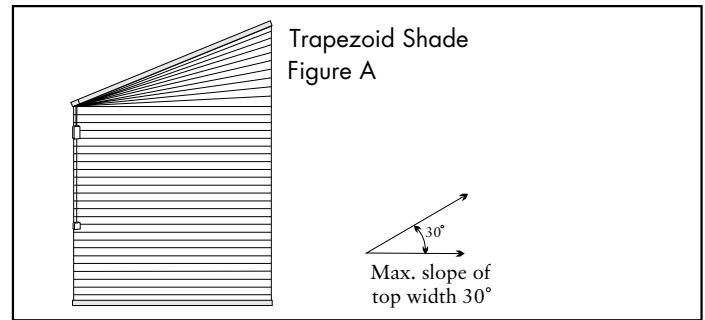

**Trapezoid Shade Operation**

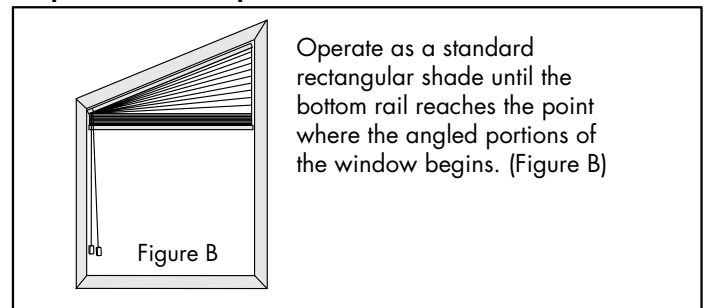

**Octagon Operation**

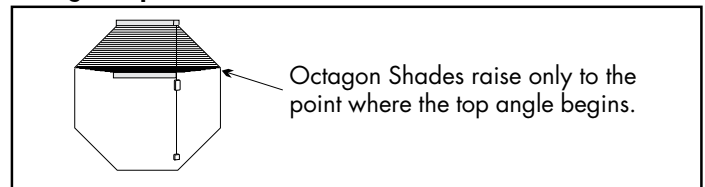

PRELUDE HARDWARE

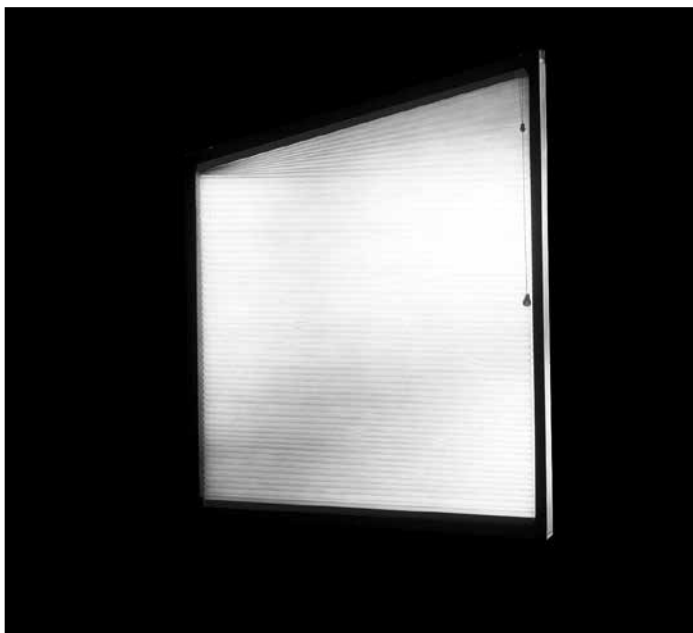

# Prelude Cellular SKYLIGHT SHADING HARDWARE SYSTEM

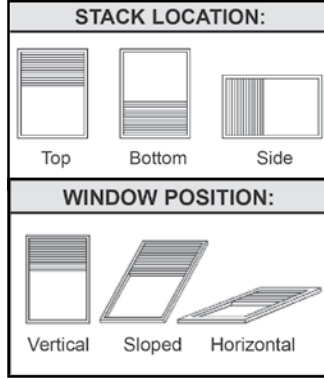
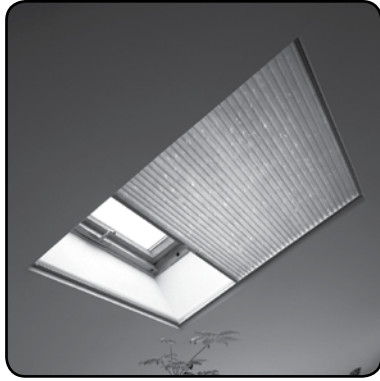

## Skylight Vertical Applications

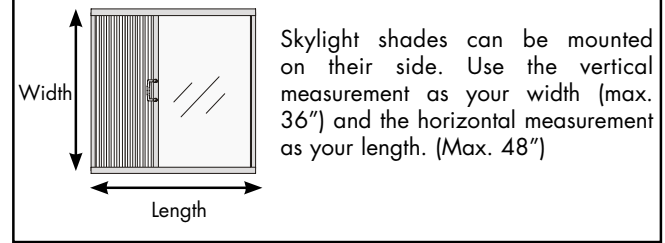

Figure A

Hardware Features	
Standard Hardware colors for Comfortex Prelude	White head and bottom rails with white cord in a white sidetrack.
Upgrades	
Fabric Wrapped Upgrade	Not Available
Designer Metallic Upgrade	Not Available
Mounting Dimensions - Inside Only	
Skylight Shading System	
Minimum required for installation	1 1/4"
Minimum Flush Inside Mount (Rail Fully Recessed)	2 1/2"
The widest width of the window cannot exceed the narrowest width of the window by more than 3/8".	
Finished Dimensions	
Inside Mount	
	<ul style="list-style-type: none"> <li>Fabric will measure ordered width less: 3/4"</li> <li>Head rail* will measure ordered width less: 3/16"</li> </ul>
* Head rail measurements include endcaps. Width and length measurements may vary +/- 1/8"	

PRELUDE HARDWARE

## Applications

- Horizontal, Angled and Vertical rectangular windows and skylights. Skylight Shading Systems are for inside mount applications only.

## Ordering Information for Skylight Shading System

- Specify when ordering: Application angle: Angled, Horizontal or Vertical.

## Accessories

- 6' Expandable Pole



Specially designed pole end fits into the handle of Skylight shades for easy operation at any angle.

## Skylight Shading System Features

- Shades can be mounted on their side. (See Figure A). Use the vertical measurement as your width (max. 36") and the horizontal measurement as your length (max. 48").
- Track system provides superior insulation and light blocking. The enclosed sides provide full privacy.
- Shades over 30" wide require support cords.
- Fabric gasket attached to moving rail to eliminate light leakage when shade is closed.

## Cellular Shade Collection

### HIGHLIGHTS CORNICE VALANCE

CELLULAR GENERAL INFORMATION



#### Highlights Cornice Valances

Elevate your windows to a whole new level of design with the Highlights Cornice Valance. Coordinate with other design elements in your room. Add a finishing touch to the top of any window treatment.

The Highlights Cornice Valance is versatile and beautiful at a price point that won't leave you wondering how to cover the rest of your windows!

Choose from any fabric in our Envision™ line and customize the valance with our 7 available return sizes to best fit your application.

Easy assembly and quick installation, with the Highlights Cornice Valance, more beautiful windows are within your reach.

Refer to your Envision price list for pricing and specifications.



#### Cut-Outs

Cut-outs are available with all cellular fabrics and are subject to approval by the Comfortex Technical Service department.

There are no limits on cut out lengths. There are limits on cut out widths:

- Cellular shade widths 18" or less      3" maximum width
- Cellular shade widths greater than 18"      5" maximum width

# Odysee Cellular Blinds



## HARDWARE OPTIONS

### Odysee Cellular Blinds Features at a Glance

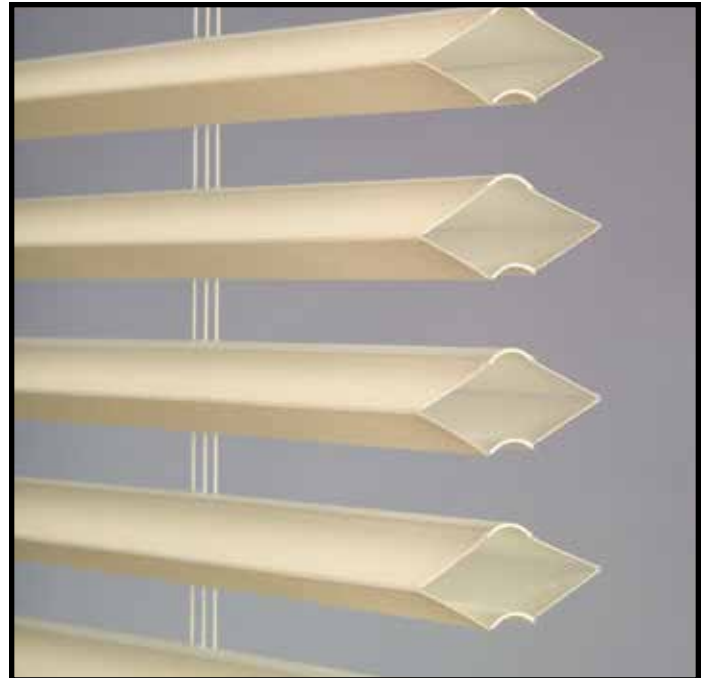
- Odysee Insulating Blinds provide the same energy saving benefits as classic cellular shades, but with the enhanced versatility of fully functional vanes.
- The Odysee vanes expand and compress to create several innovative views. Expanded vanes offer complete privacy, energy efficiency and hidden lift cords. Compressed vanes provide variable light control and substantial view through -like a wood blind.
- All Odysee Blinds are built with an integrated clutch locking system as standard.
- Odysee vanes are available with light filtering or room darkening fabric.
- Odysee provides the convenient operation of a blind with soft fabric look of a shade.
- All Odysee vanes are white to the outside for a uniform exterior appearance.
- A limited lifetime warranty serves as a commitment to your satisfaction.



## Odysee Cellular Blinds Hardware Options

	Key Features	Color Options	Hardware Size (Depth x Height)	Shade Size Available	More Information
<p><b>Cord Loop</b></p> 	<ul style="list-style-type: none"> <li>• Integrated clutch locking system</li> <li>• Cord Loop makes operation easy</li> <li>• Smooth &amp; quiet operation</li> </ul>	<ul style="list-style-type: none"> <li>• White Head &amp; Bottom Rails</li> <li>• Color matched fabric head rail insert strip</li> </ul>	<p>Head Rail: 2<sup>5</sup>/<sub>8</sub>" x 2<sup>1</sup>/<sub>8</sub>"</p> <p>Bottom Rail: 1<sup>3</sup>/<sub>4</sub>" x 1<sup>1</sup>/<sub>2</sub>"</p>	<p>Width: 20" to 108"</p> <p>Length: 12" to 120"</p>	Page 117
<p><b>Simplicity Motorization</b></p> 	<ul style="list-style-type: none"> <li>• Raise &amp; lower shade with a click of a button</li> <li>• Great for large and hard to reach windows</li> <li>• Remote can operate multiple blinds</li> </ul>	<ul style="list-style-type: none"> <li>• White Head &amp; Bottom Rails</li> <li>• Color matched fabric head rail insert strip</li> </ul>	<p>Head Rail: 2<sup>5</sup>/<sub>8</sub>" x 2<sup>1</sup>/<sub>8</sub>"</p> <p>Bottom Rail: 1<sup>3</sup>/<sub>4</sub>" x 1<sup>1</sup>/<sub>2</sub>"</p>	<p>Width: 20" to 96"</p> <p>Length: 12" to 96"</p> <p>Maximum Area: 50 Sq. Ft.</p>	Page 119

ODYSEE CELLULAR BLINDS



Odysee Cellular Blinds  
PRICING

**PRICE GROUP 42**  
**Cord Loop System -**  
**Light Filtering**

		Width In Inches														
		24	30	36	42	48	54	60	66	72	78	84	90	96	102	108
Length In Inches	36	366	411	465	523	577	618	674	731	782	836	889	940	1003	1060	1119
	42	395	448	508	577	632	692	751	815	873	934	997	1056	1119	1186	1254
	48	414	482	549	615	683	745	814	877	948	1012	1074	1146	1218	1289	1364
	54	437	506	579	655	731	795	870	945	1013	1084	1155	1234	1310	1388	1468
	60	477	545	628	702	785	867	943	1020	1101	1185	1265	1343	1425	1510	1593
	66	505	582	670	756	846	934	1015	1104	1191	1283	1370	1467	1548	1641	1732
	72	527	610	705	811	897	980	1086	1165	1265	1356	1447	1561	1646	1743	1842
	78	563	655	756	862	964	1048	1145	1250	1350	1451	1553	1658	1764	1871	1975
	84	585	692	795	907	1015	1108	1212	1322	1431	1546	1649	1756	1868	1979	2092
	90	613	724	843	952	1073	1170	1287	1405	1519	1638	1751	1870	1987	2106	2225
	96	637	756	876	1000	1129	1228	1349	1472	1593	1717	1841	1966	2092	2215	2343
	102	731	844	953	1079	1191	1288	1437	1576	1685	1796	1911	2074	2188	2321	2449
108	770	889	1004	1134	1252	1354	1508	1655	1773	1898	2009	2166	2283	2421	2558	
114	815	940	1067	1203	1335	1438	1599	1756	1880	2006	2135	2296	2422	2566	2712	
120	873	1008	1145	1287	1421	1540	1710	1880	2013	2146	2284	2459	2594	2748	2901	

■ Simplicity Motorized Lift System is not offered within the shaded area.

LIFT SYSTEM AND DESIGN UPGRADES			ADD
Solid Colors and Natural Texture Collection Fabrics	Light Filtering		Grid 42
	Room Darkening		10% to Grid 42
Personal Color System Fabrics	Light Filtering		10% to Grid 40
	Room Darkening		10% to Grid 42 PLUS 10%
Cord Loop Standard		Pg 109	FREE
MOTORIZATION			MORE INFO
Simplicity Rechargeable Motorization - Motor with Integrated Battery			Pg 120
Simplicity 5 Channel Remote			Pg 120
Simplicity 6 Channel Remote with Timer			Pg 120
Simplicity 14 Channel White Remote			Pg 120
Plug-In Charger for 7.4V Li-Ion Battery Pack			Pg 120
			ADD
			\$319
			\$41
			\$67
			\$67
			\$28

ODYSEE CELLULAR BLINDS

**Odysee Cellular Blind Motorized Pricing Examples**

**Rechargeable Simplicity Pricing Example:**

Light Filtering 42" x 60" Shade:	\$702.00
Simplicity Rechargeable Motor Surcharge:	\$319.00
Charger for Rechargeable:	\$28.00
Simplicity Remote Control:	\$41.00
<b>Total List Price:</b>	<b>\$1090.00</b>

# Odysee Cellular Blinds HARDWARE SYSTEM

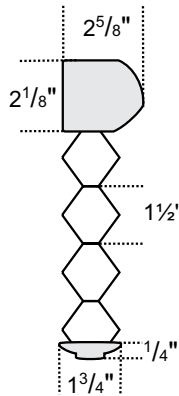
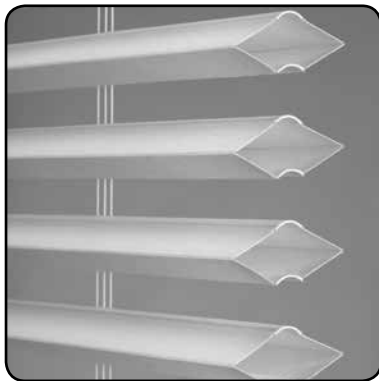

### Odysee Cellular Blind Rail Dimensions

- Depth of head rail: 2 5/8"
- Height of head rail: 2 1/8"
- Height of cell: 1 1/2"
- Depth of bottom rail: 1 3/4"
- Height of bottom rail: 1/4"

### Hardware Features

Hardware colors for all Odysee Cellular Blinds

- White head rail and bottom rail. The head rail includes a color matched fabric head rail insert strip.
- Operating cord and cord tensioner are white.
- There may be a gap from the head rail to the top vane (when the vanes are fully expanded) could be up to 3/16". The lip on the back of the head rail will prevent "view through" to the outside.

Mounting Dimensions	Odysee Cellular Blind Hardware System
<b>Inside Mount</b>	
Minimum Shallow Mount	1 1/4"
Minimum Flush Inside Mount	2 7/8"
Minimum Rear Vane Clearance	1/8"
<b>Outside Mount</b>	
Minimum Shallow Mount	1"
Minimum Flush Inside Mount	2"
Minimum Outside Mount	1/8"
<b>Side Mount</b>	
Minimum Shallow Mount	1 1/2"
Minimum Flush Inside Mount	2 5/8"
Minimum Outside Mount	1/8"
<b>Finished Dimensions</b>	
<b>Inside Mount</b>	
	<ul style="list-style-type: none"> <li>• Head rail* unit ordered width less: 3/16"</li> <li>• Blind length up to 1 5/8" more than ordered length; bottom vane may not fully extend when blind is fully lowered</li> <li>• Fabric width ordered width less 1/2"</li> </ul>
<b>Outside Mount</b>	
	<ul style="list-style-type: none"> <li>• Head rail* unit ordered width plus: 3/8"</li> <li>• Blind length up to 1 5/8" more than ordered length</li> <li>• Fabric width ordered width</li> </ul>
<p>* Head rail measurements include endcaps. Width and length measurements may vary +/- 1/8"</p>	

ODYSEE CELLULAR BLINDS

# Odysee Cellular Blinds

## HARDWARE SYSTEM

### Applications

- Standard Rectangular

### Fabric Collections

You can select fabrics from two collections:

- **Standard and Natural Textures Collection:** Solid and patterned light filtering and room darkening colors.

### Operating Cords (Standard)

- The cord loop is made of white nylon.
- Standard cord placement is right. Please specify location when ordering.
- Cord Loop System cords come in 2 foot to 15 foot lengths in 1 foot intervals. Please specify length when ordering.

Standard loop sizes are as follows:

Blind Length	Standard Loop
Up to 36"	2' (24")
36" to 60"	3' (36")
60" to 84"	4' (48")
84" to 108"	5' (60")
108" to 120"	6' (72")

### Vane Stack

Odysee Blinds are designed for both function and aesthetics with the opening and closing of the vanes, providing a view-through to the outside. While an Odysee Blind can be raised and lowered, a raised blind may result in a wavy stack resulting from the accumulation of aluminum lifters located on the cords. The aluminum lifters allow the vanes to be opened and closed



When vanes are expanded, the gap between the head rail and fabric is  $\frac{3}{16}$ "

### Stack Height

All measurements include head and bottom rails.

Blind Length	Stacking Height
Up to 12"	3 $\frac{1}{4}$ "
12 $\frac{1}{8}$ " to 24"	4 $\frac{1}{4}$ "
24 $\frac{1}{8}$ " to 36"	5 $\frac{1}{4}$ "
36 $\frac{1}{8}$ " to 48"	6 $\frac{1}{4}$ "
48 $\frac{1}{8}$ " to 60"	7 $\frac{1}{4}$ "
60 $\frac{1}{8}$ " to 72"	8 $\frac{1}{4}$ "
72 $\frac{1}{8}$ " to 84"	9 $\frac{1}{4}$ "
84 $\frac{1}{8}$ " to 96"	10 $\frac{1}{4}$ "
96 $\frac{1}{8}$ " to 108"	11 $\frac{1}{4}$ "
108 $\frac{1}{8}$ " to 120"	12 $\frac{1}{4}$ "

### Odysee Vane Characteristics

#### What size is a vane?

A vane is 1" high.

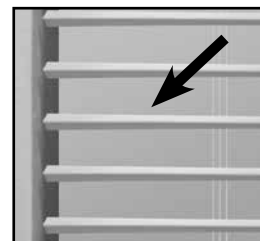

#### Vane Flare

A certain level of flare is common on the sides of the vane. This characteristic is designed into the blind to assist in closure when the vanes are fully expanded.

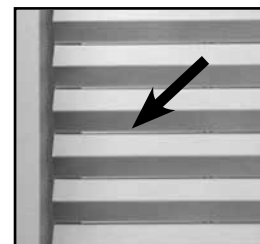

#### Vane Gap

It is not uncommon to have very small gaps between the vanes; however, the gaps should not be large enough for you to "view through" to the outside.

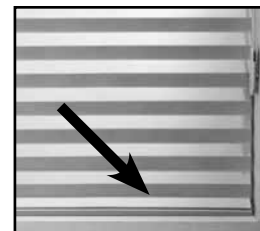

#### Bottom Vane

The bottom vane is designed to stay flat and may appear extra. In addition, some blinds may need an extra vane in order for the blind to reach the bottom sill. When the vanes are expanded, the extra vane may be partially compressed because of the size of the window.

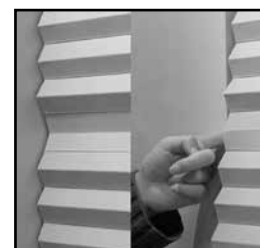

#### What do I do if an expanded vane is pushed in?

If the vane is pushed in, do not raise the blind. Carefully push the vane out with your finger or the eraser end of a pencil.

#### What do I do if the vanes do not expand or compress uniformly?

If one or more vanes hang up when opening or closing the blind, you can reset the vanes by toggling the cord loop back and forth.

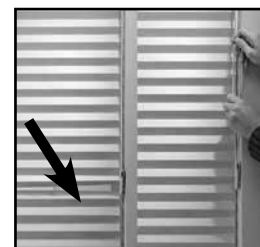

#### Are there color differences between Light Filtering and Room Darkening Vanes?

Due to the differences between the light filtering and room darkening base material, slight color variations may exist. These slight color variations are within established industry standards and should be expected.

ODYSEE CELLULAR BLINDS

# Odysee Cellular Blinds

## 7.4V RECHARGEABLE SIMPLICITY MOTORIZED HARDWARE SYSTEM

### Motorized Odysee Cellular Blinds

Odysee Cellular Blinds can be motorized with Simplicity Radio Controlled Motors.

### Rechargeable Simplicity Motors

The Simplicity Motor program features a battery powered motor utilizing a rechargeable battery wand. Simplicity motors are compact and use a radio controlled remote to raise or lower the shades.

Rechargeable Motorized Lift Systems are not offered on sizes within the shaded area on the Standard Rectangular price grids.

### Applications

- Standard Rectangular

### Mounting Requirements For Motorized Odysee Cellular Blinds

No special installation hardware or wiring requirements are needed to install motorized Odysee Blinds. See page 117 for mounting information.

### Rechargeable Simplicity Motorization Surcharges

The Rechargeable Simplicity Motorized Lift System surcharge includes a rechargeable battery. Remotes are needed to operate the shades. Refer to pricing pages.

### Important Simplicity Motorized Shade Operating and Installation Information

- Simplicity Motorized Shades installed into windows with metal casings may have a reduced radio frequency range, or may not operate at all, depending on the application.
- Do not let the antenna on the motor touch any metal objects. This may interfere with signals from the remote control.

### Simplicity Rechargeable Battery

The rechargeable battery is concealed in the head rail of the shade. A charger is required for the rechargeable battery. The rechargeable battery comes fully charged from the factory.



Charging Port on Back of Head rail.

### Solar Panel Recharge Option

Plugs in to any Simplicity Rechargeable Remote control shade (does not work with PowerTouch)

Provides constant trickle charge to 7.4v Li-Ion Rechargeable battery packs. Does not require direct sunlight, but performs best in direct sunlight applications. Will prolong the life of the charge of the 7.4v rechargeable battery packs, and in some applications will maintain charge indefinitely.

Life of charge is subject to application variables such as, size and weight of shade, frequency of use, amount of direct sunlight exposure, etc.



Dimensions of panel  
18½" x 1½"

# Odysee Cellular Blinds

## 7.4V RECHARGEABLE SIMPLICITY MOTORIZED HARDWARE SYSTEM

### Simplicity Rechargeable Battery Life

Rechargeable batteries are included with the motor.

The average battery charge will last 6-12 months based on an average sized shade raised and lowered once per day. The life of the battery charge will vary based on the type of window covering selected, the size and weight of the window covering and the number of times the shade is operated on a daily basis.

The battery can be recharged up to 500 times. It takes approximately 5 hours to recharge the motor when fully depleted.

### Ordering Information for Rechargeable Motorized Cellular Shades

#### Simplicity Motor Option

- Specify IB or OB mount and rail color.
- Specify remote and other accessories if needed.
- Specify one or more battery chargers.

#### Please Note:

- Not all motors run at the same rate of speed.
- Simplicity motors have a "Favorites" position setting. If the homeowner wants to set several shades at the same intermediate position, follow instructions provided with installation manual.
- Simplicity Rechargeable Motorized Cellular Shades are programmed at the factory with the "up and down" limits. The shades are **UNLINKED** from the remote so they are not able to operate during shipping. Each shade should be installed **after** linking it to the remote.
- The Simplicity remotes utilize one 3V battery. Batteries are included. Comfortex will warranty batteries for up to 3 months from date of purchase. Remote batteries are not covered by the warranty.
- **REMEMBER: Order at least one charger if ordering rechargeable motors.**

### Simplicity Motorized Shade Warranty

Please see page 120 for complete Comfortex warranty information.

### Battery Charger

8.4 Volt charger requires a standard power outlet to recharge the battery wand. Must specify charger when ordering a Simplicity Rechargeable Wand Shade. The charger plugs into the charger port. The charger is black and comes with a 156" wire. The dimensions are 1" wide x 2½" length x 1¾" deep.



### 5 Channel Remote Control

The **5 Channel (5C) remote** can operate up to five shades individually or 5 groups. Simplicity Rechargeable Motorized Cellular Shades are programmed at the factory with the "up and down" limits. The shades are **UNLINKED** from the remote so they are not able to operate during shipping. Each shade should be installed **after** linking it to the remote.



Simplicity 5C remotes and holders are white or black in color. The remote comes with a holder which can be mounted to a wall for easy storage. The range of the remote is approximately 80 feet.

### 6 Channel Timer Remote Control

The **6 Channel (6C) timer remote** combines the functionality of a six channel hand-held control with the convenience of a programmable timer.

- The 6C timer remote allows for 18 different scheduled actions.
- Manual function disables the timer so then the remote operates as a held remote.



Simplicity 6C remotes and holders are white in color. The remote comes with a holder which can be mounted to a wall for easy storage. The range of the remote is approximately 80 feet.

Simplicity Rechargeable Motorized Cellular Shades are programmed at the factory with the "up and down" limits. The shades are **UNLINKED** from the remote so they are not able to operate during shipping. Each shade should be installed **after** linking it to the remote.

A **14 Channel (14C) remote** is also available. This remote is required for TDBU motorization but can be utilized on all Simplicity motorized shades. See page 58 for more information.

### Simplicity Motor Hand Held Remotes Operation

Press the up or down button on the remote to raise or lower the shade to your desired position.

To reprogram channel assignments, please refer to the installation instructions and/or view the video at: [comfortex.com/comfortex-dealers](http://comfortex.com/comfortex-dealers).

ODYSEE CELLULAR BLINDS

# Odysee Cellular Blinds

## GENERAL INFORMATION

### Operating Cord Loop Odysee Blinds

- A single cord loop and clutch combination is used to raise and lower the blinds, as well as open and close the vanes.
- To compress the vanes or lower the blind, pull on the rear of the cord loop. To expand the vanes or raise the blind, pull on the front of the cord loop.

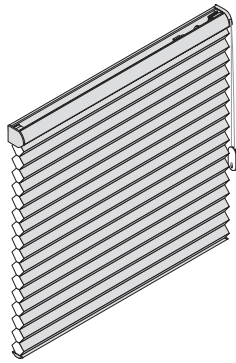

Privacy Position  
(Vanes expanded)

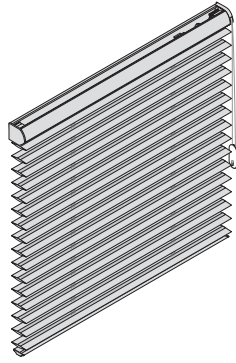

View-Through Position  
(Vanes compressed)

If at any time the vanes do not expand or compress uniformly you can reset the vanes by toggling the cord loop. Opening and closing the vanes should re-align them with uniform expansion or compression.

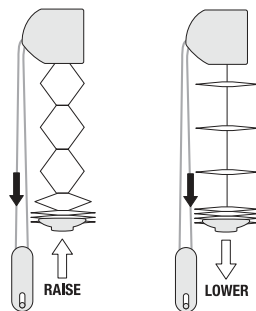

### Bottom Rail

Odysee Cellular Blinds feature a creamy white bottom rail.

When the vanes are expanded (closed), the bottom rail touches the window sill. When the vanes are compressed (open), the bottom rail may lift off the sill slightly. This is normal.

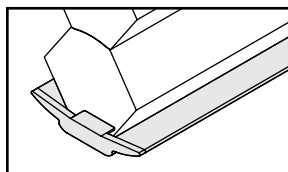

### Odysee Certified Fabrics

The GREENGUARD Environmental Institute has established performance based standards to define goods with low chemical and particle emissions for use indoors.

Odysee fabrics have earned the following certifications:

- GREENGUARD Indoor Air Quality Certified® certification for low emitting interior building materials, furnishings, and finish systems.
- GREENGUARD Children & Schools<sup>SM</sup> product certification for low emitting interior building materials, furnishings, and finish systems used in educational (day care and K-12) environments.



ODYSEE CELLULAR BLINDS

**Cellular Shade Collection**  
**GENERAL INFORMATION**

CELLULAR GENERAL INFORMATION

**Scotchgard™ and Certified Fabrics**

**Scotchgard Protection**

Scotchgard™ Protector is available with all cellular Shades. Scotchgard™ keeps your shades looking newer, fresher and cleaner longer.



A combination of the latest advances in stain release and repellency provides exceptional stain protection. Spills wipe away easily and most dirt and stains lift out when cleaned. Both sides of the fabric are treated with Scotchgard.

**GREENGUARD Certified Fabrics**

GREENGUARD Indoor Air Quality Certified® Fabrics  
 The GREENGUARD Environmental Institute has established performance based standards to define goods with low chemical and particle emissions for use indoors.

The following fabrics have the passed GREENGUARD Indoor Air Quality Certified® certification program for low emitting interior building materials, furnishings, and finish systems:

- Symphony (All)
- Virtuoso (All)
- Baritone (All)
- Premiere (All)
- Natural Linen Flax
- Debut (All)
- Linen Weave

The following fabrics have the passed GREENGUARD Children & Schools™ product certification program for low emitting interior building materials, furnishings, and finish systems used in educational (day care and K-12) environments:

- Symphony Light Filtering
- Symphony Blackout

**Symphony Flame Resistant Fabrics**

Symphony Flame Resistant Fabrics have been registered as a Flame Resistant Products by the California State Fire Marshall for products identified in section 13115, California Health and Safety Code (California CHSC). Copies of the certificates are located on the Comfortex.com/comfortex-dealers web site or on the On Demand Mobile library.

**Color Selection**

Use the current Cellular Shades Collection sample book to select colors from the Symphony light filtering fabric collection. All thirty colors are available in 3/8" Symphony light filtering double cell and 3/4" light filtering single cell.

**Ordering Flame Resistant Shades**

The SKU structure for Symphony Flame Resistant material is: 3012 05 XXX (XXX representing the color number).

**To order Symphony Flame Resistant Shades:** Use the SKU number listed on the decks.

The SKU structure for the 3/4" Symphony Flame Resistant material is: 2512 05 XXX

**To order 3/4" Symphony Flame Resistant Shades:**

Use the Symphony three digit color number to identify your desired color.

In this example:  
 2512 05 108



**EZ Level on Comfortex Cellular Shades**

EZ Level makes quick work of leveling without cords to cut or tuck into a rail. No special tools needed – just use a nickel, quarter or penny to adjust plug on the bottom rail.

EZ Level is standard on all Cellular and Pleated Shades with the following hardware systems:

- Standard and Deluxe Cord Lock
- Cordless Ultra
- Cord Loop
- SlumberShades
- Simplicity Motorized Systems

EZ Level is not available with Lift & Lock Cordless.

**How does EZ Level work?**

- Slightly raise the bottom rail you want to level.
- Insert a coin or flat head screwdriver into the adjustment screw and turn it.
- Turn the adjustment screw clockwise or counter clockwise to make slight adjustments up or down. One quarter turn of the adjustment screw will move the bottom rail up or down 1/4".
- Lower the rail to check the level and make further adjustments if necessary.



## Cellular Shade Collection

### GENERAL INFORMATION

#### Cleaning and Care

While beautiful and pleasing to the eye, all Comfortex products are designed to be durable, easily cared for and easily cleaned. Our non-woven fabrics are inherently anti-static and repel dust, but occasional feather dusting or vacuuming may be necessary to keep the fabrics clean and bright. Comfortex Cellular fabrics may be ultrasonically cleaned.

**Cleaning Virtuoso Blackout, Baritone Blackout and Symphony Blackout Fabrics:** Our blackout fabrics are inherently anti-static and repel dust, but occasional cleaning may be necessary to keep the fabrics clean and bright. The fabric can be dusted with a soft, clean cloth, feather duster or lightly vacuumed with a soft brush attachment. To spot clean, use a cloth or sponge dipped in a light solution of lukewarm water and clear dish detergent and lightly dab. Do not scrub the surface. Rinse thoroughly.

#### Cleaning all other Comfortex Cellular or Pleated Fabrics:

Our light filtering and room darkening fabrics are inherently anti-static and repel dust, but occasional cleaning may be necessary to keep the fabrics clean and bright. The fabric can be dusted with a soft, clean cloth, feather duster or lightly vacuumed with a soft brush attachment. Spills and stains can be lightly blotted with a cloth or damp sponge. More difficult stains may require soaking in water with mild soap. For this, remove the shades from the window and soak in warm water. Complete immersion of hardware is not recommended.

DO NOT submerge the Cordless Ultra head rail in water. When damp, lay flat to dry or place back in window and raise tightly to recrisp pleats. Please test any stronger cleaners on an unobtrusive portion of the shade before using.

For additional advice on care or cleaning, please contact our Technical Services Department.

#### Cleaning and Care of Odysee Cellular Blinds

Regular feather dusting or vacuuming will keep Odysee Cellular Blinds looking new for years.

Odysee Cellular Blinds can be spot cleaned. Gently blot the stain with a clean, non-alcohol baby wipe. Instead of a baby wipe, you may use a clean white cloth with a mild cleaning solution. Support the fabric from behind using another clean, dry cloth. Clean the fabric using a gentle blotting action. Do not rub the fabric. Any abrasive action may cause the fabric to pill or distort. Allow the fabric to air dry with vanes expanded.

Forced air can also be used to blow out dirt and debris from within the vanes using clean compressed air or a hair dryer on the COOL setting.

Odysee Cellular Blinds can also be ultrasonically cleaned. Do not immerse the head rail. Comfortex acknowledges these cleaning methods as being safe and effective. We cannot attest to the quality of equipment or services provided by any independent cleaning facility.

#### Scotchgard™ Treated Shades

The following are the recommended cleaning and care instructions for window treatments with fabric treated with Scotchgard™ Protector.

- Gently blot liquid stains immediately with a clean, white cloth.
- If stain remains, prepare a solution of ¼ teaspoon of clear, non-bleaching dish detergent mixed with 1 cup of lukewarm water. Dampen a clean white cloth and gently blot the stain.
- Do not overwet the fabric or excessively rub the stained area.
- See the Installation and Care instructions for complete details.

For additional assistance with stain removal, call the Scotchgard™ Protector Service Center at 1-800-433-3296. Customer Care representatives are available Monday through Friday, 8am to 6pm CT.



## Cellular Shade Collection

### GENERAL INFORMATION

## Cellular Shade

### MEASURING INSTRUCTIONS

Comfortex accepts measurements down to  $\frac{1}{16}$ " increments.

#### Inside Mount

Use a steel tape to measure the opening at three different places, and use the narrowest dimension when ordering. Be exact! The factory will make the shade  $\frac{3}{16}$ " narrower so it will not rub against the window casing. Measure the height of the window from the top (soffit) down to the sill.

#### Outside or Ceiling Mount

Use a steel tape to measure the exact height and width of the area to be covered. It is recommended that the shades overlap the window by at least  $1\frac{1}{2}$ " on each side. When installation has no sill, allow the shade to overlap the bottom of the window casing by at least  $1\frac{1}{2}$ ". Shade fabric will measure width indicated on the order form.

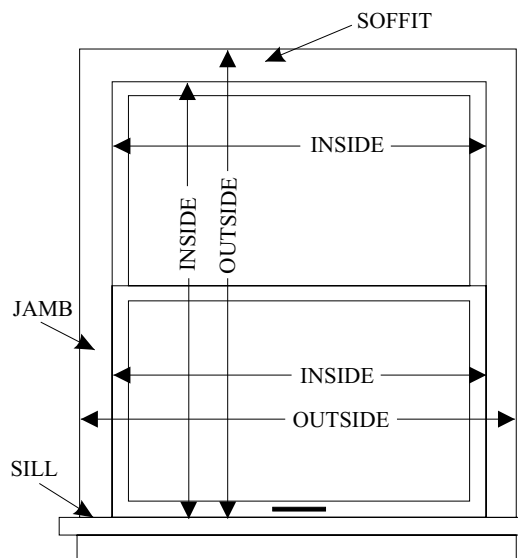

## Measuring for Specialty Shapes

Templates are required with some specialty shade orders. Consult the individual product sections of this guide for specifics regarding accurate measurements and mounting information.

### Arches and Quarter Round Circles

- Measure the window height and width appropriately for an inside or outside mount.
- With perfect arches, the height will be one half the width. With perfect quarter rounds, height will equal width. If the arch or quarter round is perfect, **a template is not required.**
- Windows with imperfect arch measurements do not maintain the height/width relationship. Templates **are required** for these windows.

### Trapezoids

- Measure the window height and width appropriately for an inside or outside mount. For outside mounts, remember to add the desired amount of overlap.
- Measure all four sides for accurate fabrication. Provide all measurements. **Templates are not required.**
- The slope angle must be measured with a protractor. Slope is the angle between slope and a horizontal line. The maximum slope is 30 degrees.

### Octagons

- Measure the window height and width appropriately for an inside or outside mount. Be sure to measure the width at the shade's widest point.
- Provide the width, length and the length of one side when ordering.

## Cellular Shade Collection

### GENERAL INFORMATION

#### Making the Perfect Template

Tape brown craft paper over the window opening. Be sure to allow plenty of overlap and check to see that the paper is smooth and pulled taut. Do not use newspaper as the ink can rub off on fabric. Do not use paper that has been folded. Notice the outline of the framework superimposed on the template as the light filters through the window. You may create the template in one of two ways:

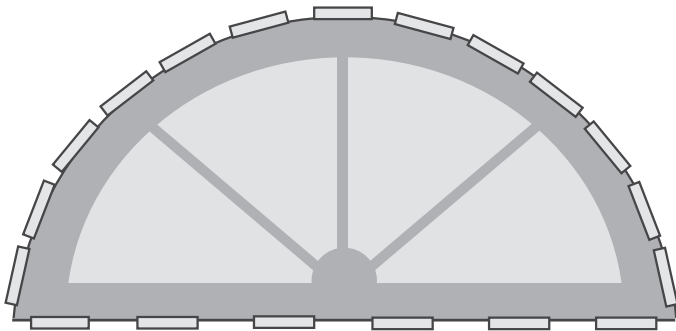

Trace the outline of the window with a pencil and continue along the side of the window frame. Once the window is completely traced, remove the craft paper from the window. Cut out the traced shape with a pair of scissors.

You may choose to skip tracing the window outline with a pencil and cut out the shape immediately with a razor knife.

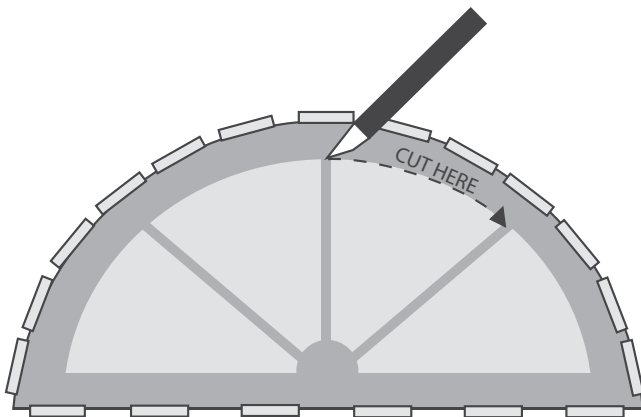

Once your template is cut, double check its width and height with your initial measurements. Test the template by placing it in the window. Check for light gaps, uneven cutting of curves etc. Trim or remake if necessary.

With arch top shades, fold the template in half. Check the outline of the curve for smoothness, light gaps and curve continuity. Place the template in the window and check it for light gaps or uneven cutting of curve. Trim or remake it if necessary.

On the front of the template, mark the shade measurements along with your company name, account number, sidemark, shade style and color. Be sure to indicate inside or outside mount, the room side and which ends of the template are top and bottom. Do not take any deductions on inside mount shades. The factory will make all necessary allowances for inside mounts.

**Remember:** The quality of the finished shades depends heavily on the quality of the template supplied. Do not hesitate to remake a template if you feel uncomfortable of the quality of your first attempt.

**Template Kits:** Comfortex offers template kits which includes brown craft paper, razor knife, instructions and order form. Please contact Customer Service or visit [www.comfortex.com](http://www.comfortex.com) to order. Stock number: 751000

## Cellular Shade Collection

### GENERAL INFORMATION

#### Conditions of Sale

All Comfortex products are custom fabricated to your exact specifications. We cannot accept responsibility for errors in ordering or cancellations and charges after the order is in production.

#### Policies

Our policies are designed to provide a guide for doing business with Comfortex. Our first priority and number one policy is to provide the highest level of service and total satisfaction.

#### Freight Policy

##### Fabricated Shades/Blinds

Comfortex will ship all orders for fabricated shades or blinds freight free via UPS, FedEx Ground or other similar method within the Continental US.

**Transportation Surcharge:** A \$6.00 per unit transportation surcharge will be added to all fabricated product orders shipping within the Continental US; including shades/blinds, vane packs, individual vanes, tracks, valance and cut yardage orders. Exception: Vertical Sheer Shadings, Ovation Cellular Slider and Envision Panel Track system will incur a \$15 per unit transportation surcharge up to 96".

**Oversized:** In addition to the transportation surcharge, a \$45 per unit Common Carrier surcharge will be added to all fabricated products shipping within the Continental US, including shades/blinds, Vertical Sheer Shadings, Ovation Cellular Slider, Envision Panel Track system, valances, vane packs, individual vanes, tracks, and cut yardage orders with widths of over 96 inches.

**Hawaii:** Shipments to Hawaii will incur a freight charge of \$26.00 per unit when shipped from within the Continental US. In Addition, a \$132.00 per unit Common Carrier surcharge for oversized shades/blinds (over 96") will be added to orders shipping to Hawaii.

**Alaska:** Shipments to Alaska will incur a \$26.00 per unit transportation surcharge when shipped from within the Continental US. In addition, a \$132.00 per unit Common Carrier surcharge for oversized shades/blinds (over 96") will be added to orders shipping to Alaska from within the Continental US.

**Canada:** Shipments to Canadian Dealers will incur a \$7.75 per unit transportation surcharge when shipped from within the Continental US. In addition, a \$75.00 per unit Common Carrier surcharge for oversized shades/blinds (over 96") will be added to orders shipping to Canada from within the Continental US.

**Other Countries:** All US Dealers requesting to ship orders outside the USA, must provide a Freight Forwarder for Comfortex to ship to within the Continental US. Comfortex cannot ship directly to your customers located outside USA.

#### Components and Fabric

Comfortex will prepay all freight charges on shipments of component and fabric orders over \$3,500 in value within the Continental US. Fabric and component orders less than \$3,500 will be subject to freight charges.

#### Shutter Components and Tools

Comfortex will prepay all freight charges on shipments of stock component and tool orders exceeding \$20,000 in value, within the Continental US only. All orders less than \$20,000 will be subject to all freight charges. Customers can elect a carrier of choice and receive a freight bill directly from the carrier or Comfortex will select a carrier and invoice the customer for the freight charges. Comfortex makes every effort to provide the most economical carrier and shipping method possible.

#### Charged Marketing Materials

All charged marketing materials will incur freight charges. Marketing materials may ship on separate days, from different locations. Freight charges are calculated per package, not per order.

#### Specifications

All Comfortex products are designed and tested to perform as intended within established, published parameters. Requests for "custom fabrication" of products outside of our published specifications may be considered, but are at the discretion of the Comfortex Technical Services department. Restrictions and additional charges apply.

**Download installation instructions, order forms or additional price list copies on the Comfortex OnDemand Library or [www.comfortex.com/comfortex-dealers](http://www.comfortex.com/comfortex-dealers) in the Dealers Resource Center.**

**Cellular Shade Collection**  
**GENERAL INFORMATION**

**⚠️ WARNING**

**⚠️ ADVERTENCIA**

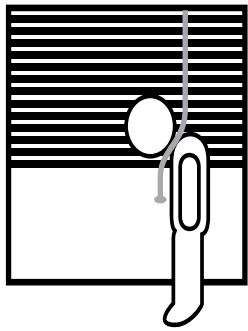

Window Blind Cord Can STRANGLE Your Child.

To prevent strangulation, purchase cordless products or products with inaccessible cords.

La cuerda ciega de la ventana puede ESTRANGULAR su niño.

Para evitar el estrangulamiento, compre alternativas inalámbricas o productos con cables inaccesibles.

**Child Safety**

Comfortex has a long history of designing new child-safety products and is proud to provide a leadership role in cooperating with the Consumer Product Safety Commission (CPSC) for the development of policies and guidelines for the industry by serving on the WCMA Standards Development Committee.

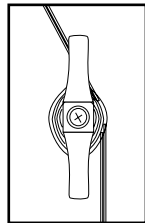

Cord Cleat

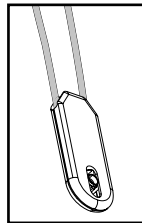

Cord Tensioner

All Comfortex products have been fully tested and proven to comply with the current WCMA Standards for safety of corded window coverings.

Be aware that it is possible for children to become entangled in window covering cords. To reduce the risk of accidents, all cords must be kept out of the reach of children.

A cord cleat or cord tensioner is an effective way to implement this essential precaution. Please use them.

To mount the cord cleat at a safe height, take into account furniture or other objects upon which a child may climb. Then, after the use of the blind, simply wrap the excess cord around the cleat.

## Cellular Shade Collection

### GENERAL INFORMATION

#### Cellular, Pleated and Prelude Shades

#### Odysee Cellular Blinds Warranty Information

Comfortex warrants that its window treatments will be free from defects in materials and workmanship for as long as the original residential purchaser owns the product, provided that the product was installed properly and in accordance with the installation instructions. The Limited Lifetime Warranty is extended to the original residential purchaser only, in the original window for which it was installed.

The Warranty does not include any conditions or damages resulting from accidents, alterations, misuse, abuse, misapplication, improper handling, installation, repairs, operation, cleaning, exposure to any and all natural and manufactured excessive heat sources. (Excessive heat sources include, but not limited to; magnification of sun light through cubes of glass, heaters of any kind, ovens, candles, lighting fixtures, etc.) This warranty does not cover variation in fabric color, grain, or texture in natural wood products nor excessive warping of wood slats in high humidity areas. Loss of pleating is not covered if the product is not being cycled (held in the raised position a portion of the time). Normal wear and tear is not covered.

All moving parts, such as cords and strings ( internal and external), will eventually wear out and fabric may fray. Comfortex considers these things as normal wear and tear and will carry a five year Limited Warranty. All fabric, including fabric vanes, panels, inserts, and shades carry a five year Warranty. Fabric cell separation is covered for a lifetime. See Comfortex Standard Return and Repair Policy for more details.

This Limited Warranty does not cover transportation costs to and from the retailer, costs of removal, re-measure, reinstallation of product, or any incidental or consequential damages.

If a Comfortex product is found to be defective in materials or workmanship, we will, at our discretion, repair, replace or refund the cost of a product which fails to conform to this Limited Warranty. Colors vary from lot to lot and may not exactly match sample swatch, sample book, or previous purchases. Discontinued components or color selections will be replaced with the closest equivalent current product. This shall be your sole remedy under this Limited Warranty.

To obtain service, contact the Dealer from whom you purchased the product.

This Warranty is exclusive and in lieu of all other obligations, liabilities or warranties. In no event shall Comfortex or its licensed fabricators or distributors be liable for incidental or consequential damages, or for any other damage, loss or expense, cost or fee associated with such damage. In some

states, exclusions for incidental or consequential damages are not allowable. Comfortex Dealers and Fabricators must use safety devices supplied by Comfortex in accordance with Window Covering Safety Counsel guidelines.

This Warranty gives you specific legal rights, and you may also have other rights, which vary from state to state. Policy is subject to change without notice.

This Limited Warranty is exclusive of commercial use. Contact Comfortex Technical Service for more information. No agent, representative, dealer or unauthorized employee has the authority to increase or alter the obligation of this Warranty.

This Limited Warranty supersedes any previous versions.

#### Motorized Cellular and Pleated Shades and Odysee Cellular Blinds Warranty

##### PowerTouch and Rechargeable Simplicity Motorization

We offer a 5 year warranty on all motors and controls. Specifically, we warrant the Simplicity motors and controls to be free from defects in material and workmanship under normal and proper use for a period of 5 years commencing with the date stamped on each product. If the Simplicity product fails within this 5 year period, we will repair or replace it free of charge through your end product supplier.

#### Custom Graphics Cellular Shades Color Warranty

Comfortex utilizes state of the art technology to provide you Custom Graphics Shades within 2 Delta-E (DE) of the sample fabrics found in the Comfortex Collections Cellular and Pleated Sample Book. When viewed under different lighting sources such as fluorescent, incandescent, halogen, ultraviolet and others, fabrics may appear different to the eye. Comfortex utilizes the worldwide lighting standards of Daylight 65 (D65) as our official standard for measuring and qualifying color accuracy, because D65 daylight bulbs best represent actual "daylight" illumination. Slight color variations (under 2 DE) are within established industry standard and should be expected.

This warranty is in addition to Comfortex limited lifetime warranty.

## Cellular Shade Collection

### GENERAL INFORMATION

#### Scotchgard™ Warranty

Comfortex Window Fashions provides a limited warranty for fabrics treated with Scotchgard™ Protector against permanent stains for a period of 1 year from the date of original purchase.

This warranty excludes conditions or damages resulting from accidents, alterations, exposure to the elements, and exposure to any and all natural and manufactured excessive heat sources, or failure to follow the Installation and Care instructions. This warranty also excludes fabric submerged in water or cleaning solutions, or treated with household products that may alter or deplete the effectiveness of the treated fabric. In addition, the following types of stains are excluded from this limited warranty: pet stains, bodily fluids, stains caused by wine, bleach, plant fertilizers, acne medication, misuse or abuse. This warranty is not a cleaning contract and does not cover the cleaning of fabrics that are soiled or discolored through daily use. This warranty coverage is limited to residential use and is not transferable.

The following are the recommended cleaning and care instructions for window treatments with fabric treated with Scotchgard™ Protector.

- Gently blot liquid stains immediately with a clean, white cloth.
- If stain remains, prepare a solution of ¼ teaspoon of clear, non-bleaching dish detergent mixed with 1 cup of lukewarm water. Dampen a clean white cloth and gently blot the stain.
- Do not overwet the fabric or excessively rub the stained area.
- See the Installation and Care instructions for complete details.

For additional assistance with stain removal, call the Scotchgard™ Protector Service Center at 1-800-433-3296. Customer Care representatives are available Monday through Friday, 8am to 6pm CT.

Should the results of the cleaning and care instructions not result in the removal of permanent stains covered by this limited warranty, Comfortex will retreat or replace the fabric, at its discretion, for a period of 1 year from the date of original purchase. Customer must provide proof of purchase and provide proof the stain occurred during the warranty period. Shipping and handling costs to send the window treatment back to Comfortex are the responsibility of the customer.

This warranty gives you specific legal rights, and you may also have other rights which vary from state to state.

©2020 COMFORTEX CORPORATION

™ is a trademark of Comfortex Corporation. ® is a registered trademark of Comfortex Corporation. The GREENGUARD INDOOR AIR QUALITY CERTIFIED Mark is a registered certification mark used under license through the GREENGUARD Environmental Institute. GREENGUARD Children & Schools<sup>SM</sup> is a service mark used under license through the GREENGUARD Environmental Institute. Energizer® is a registered trademark of Energizer Holdings, Inc. Symphony® and Soprano® are registered trademarks of Comfortex Corporation. Symphony® is covered by U.S. Patent Nos. 5,193,601 and 4,974,656 respectively. Ovation™ Cellular Slider is covered by one or more of the following U.S. Patent Nos.: 4,862,941, 4,858,668, 4,915,153, D346,032, D324,108, 4,450,027, 4,631,108, 4,603,072, 5,690,778, 5,664,773, 6,319,586, 5,482,750, 5,601,885 and 4,631,217. SlumberShade™ is covered by U.S. Patent No. 8,371,355. Karma-Light™, PowerTouch™, Timeless Textures™, Debut™, Cordless Ultra™, Sunset™, Balcony™ and Ovation™ are trademarks of Comfortex Corporation. Other U.S. and foreign patents pending. All rights reserved.

Odyssey is covered by U.S. Patent Nos. 5918655, 4372432, 4433765, 4623012, 5697630, 5058720, 5228491, 5375643, 5733632 and 5680891. Additional U. S. and foreign patents pending.



Midwest  
Designer  
Supply

**1-888-523-2611**

**Midwest Designer Supply, Inc.  
N30W22377 Green Road Ste C  
Waukesha, WI 53186  
(262) 523-2600  
Fax (262) 524-1007  
[www.midwestdesignersupply.com](http://www.midwestdesignersupply.com)**

*MDS - your one source for window fashions.*